

Fairy Circles

Fairy Circles

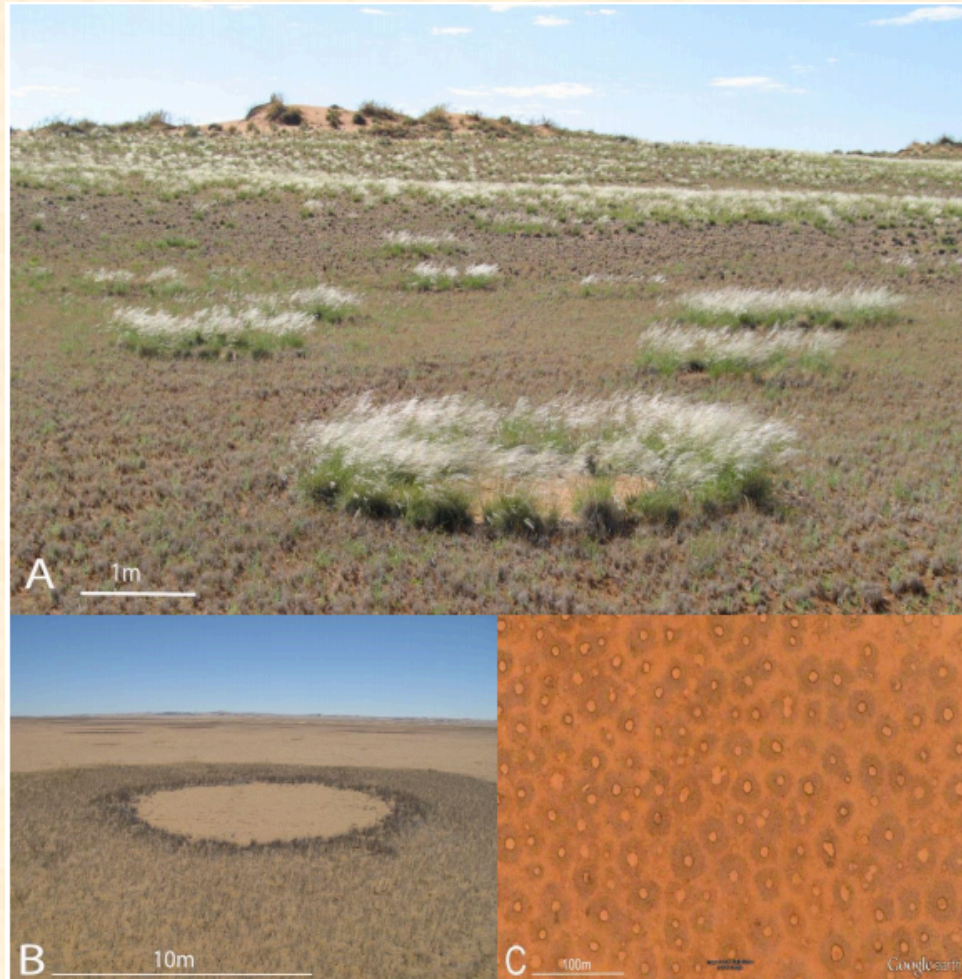
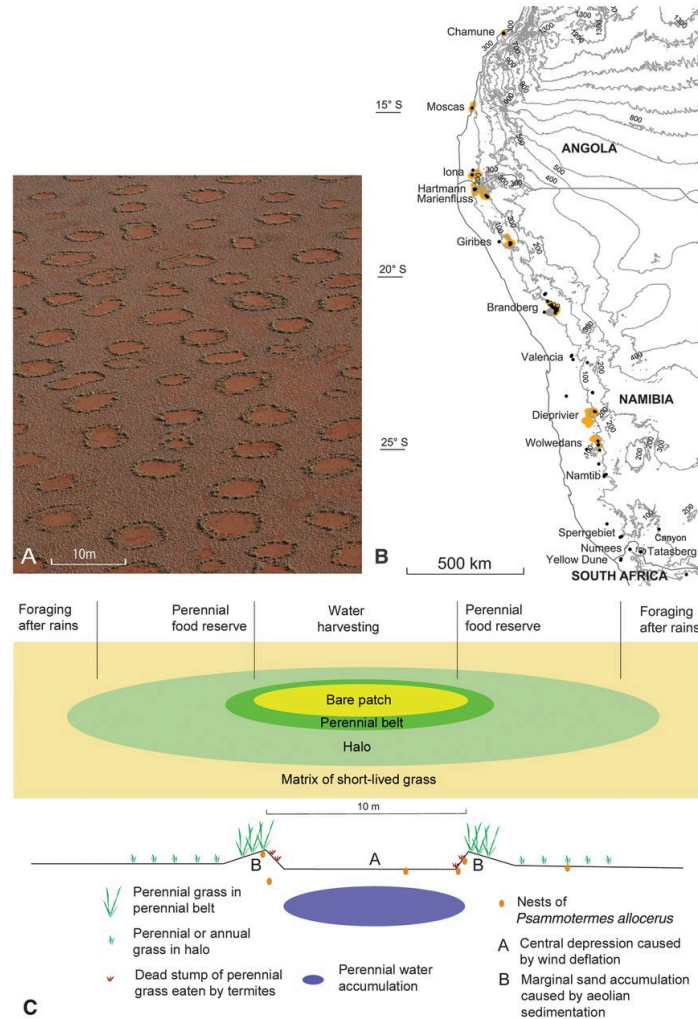

Fig. 1 (A) Spatial pattern of FCs. (B) Geographical distribution of FCs (black dots) and hotspots of FC occurrences at wider landscape scale (yellow clusters).



N Juergens Science 2013;339:1618-1621



Part C

Nest Building

Nest Building by Termites (Natural and Artificial)

Mound Building by *Macrotermes* Termites



2013/4/12

Structure of Mound

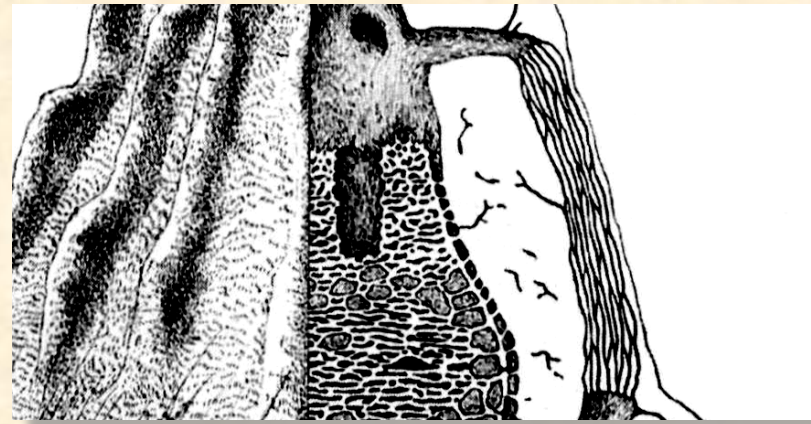
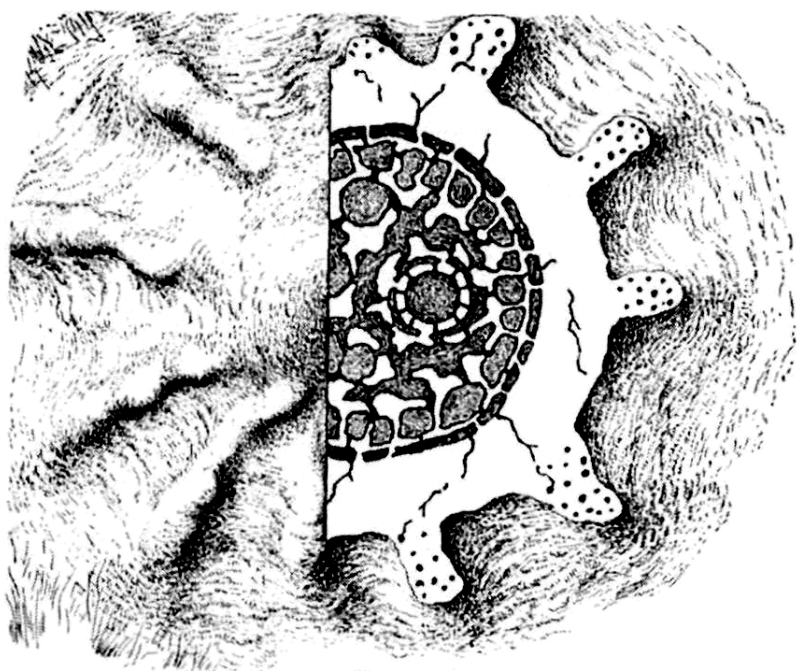

Construction of Mound

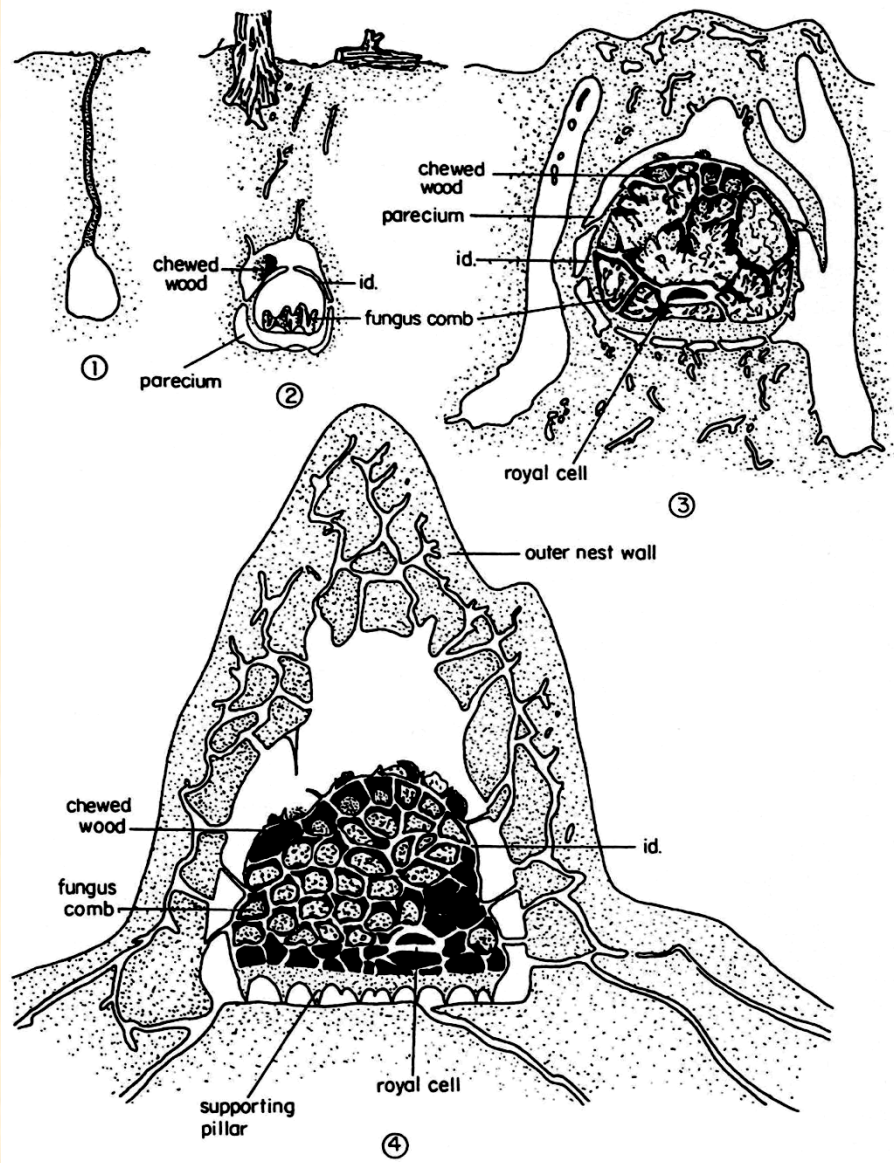

- (1) First chamber made by royal couple
- (2, 3) Intermediate stages of development
- (4) Fully developed nest

Termite Nests



2013/4/12

Alternatives to Self-Organization

- Leader
 - directs building activity of group
- Blueprint (image of completion)
 - compact representation of spatial/temporal relationships of parts
- Recipe (program)
 - sequential instructions specify spatial/temporal actions of individual
- Template
 - full-sized guide or mold that specifies final pattern

Basic Mechanism of Construction (Stigmergy)

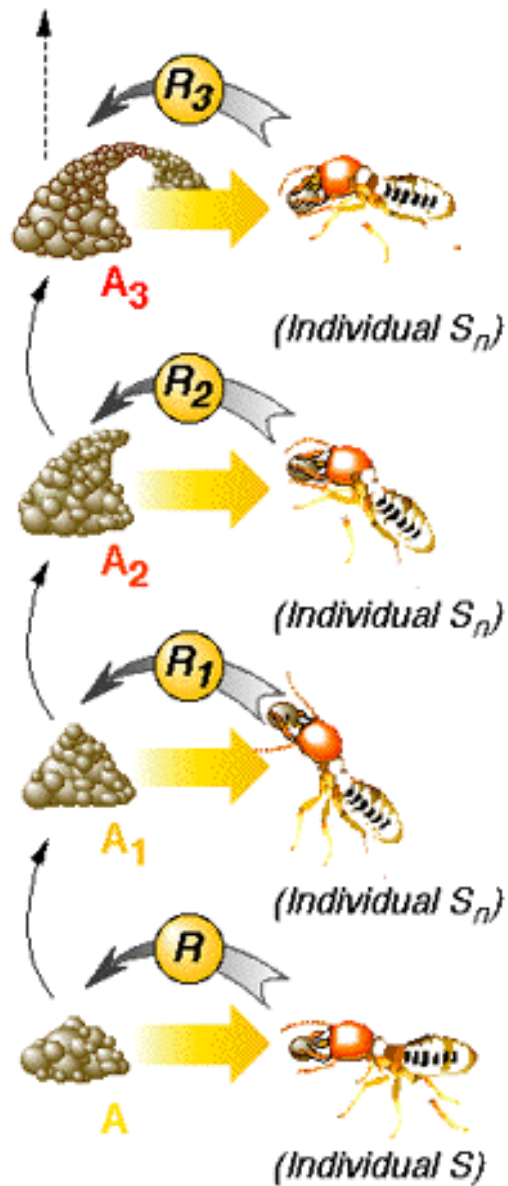

- Worker picks up soil granule
- Mixes saliva to make cement
- Cement contains pheromone
- Other workers attracted by pheromone to bring more granules
- There are also trail and queen pheromones

Construction of Royal Chamber

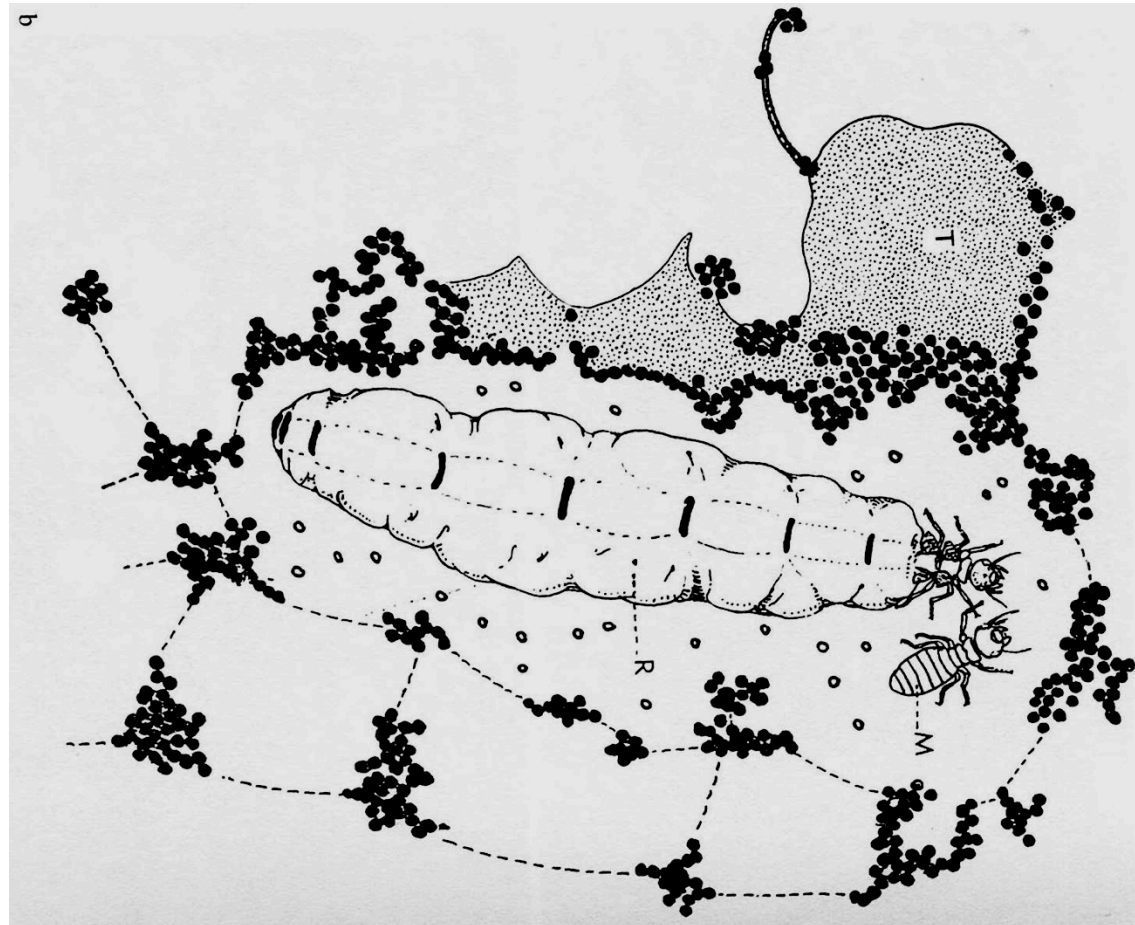

Construction of Arch (1)

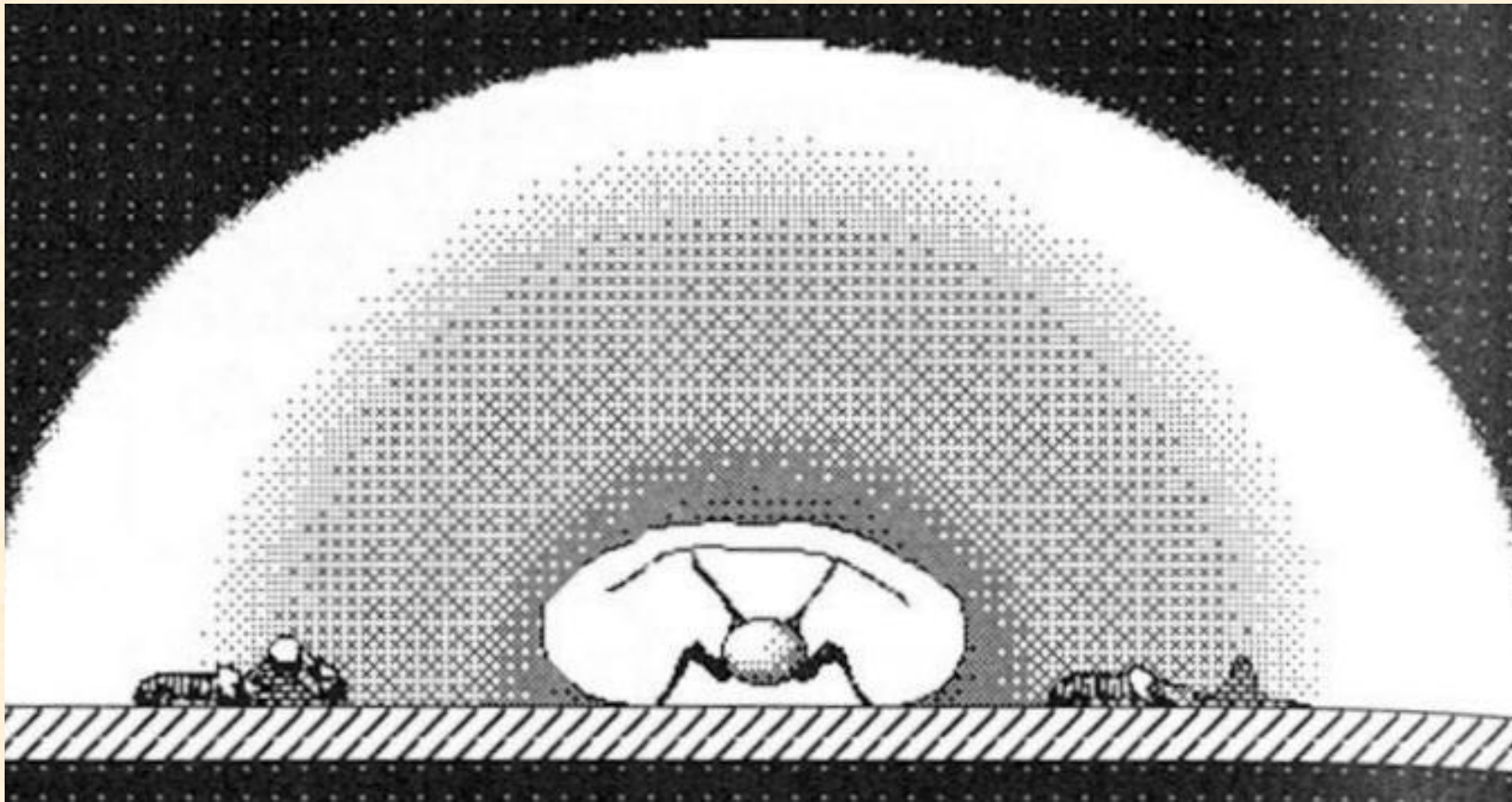

2013/4/12

Fig. from Bonabeau, Dorigo & Theraulaz

13

Construction of Arch (2)

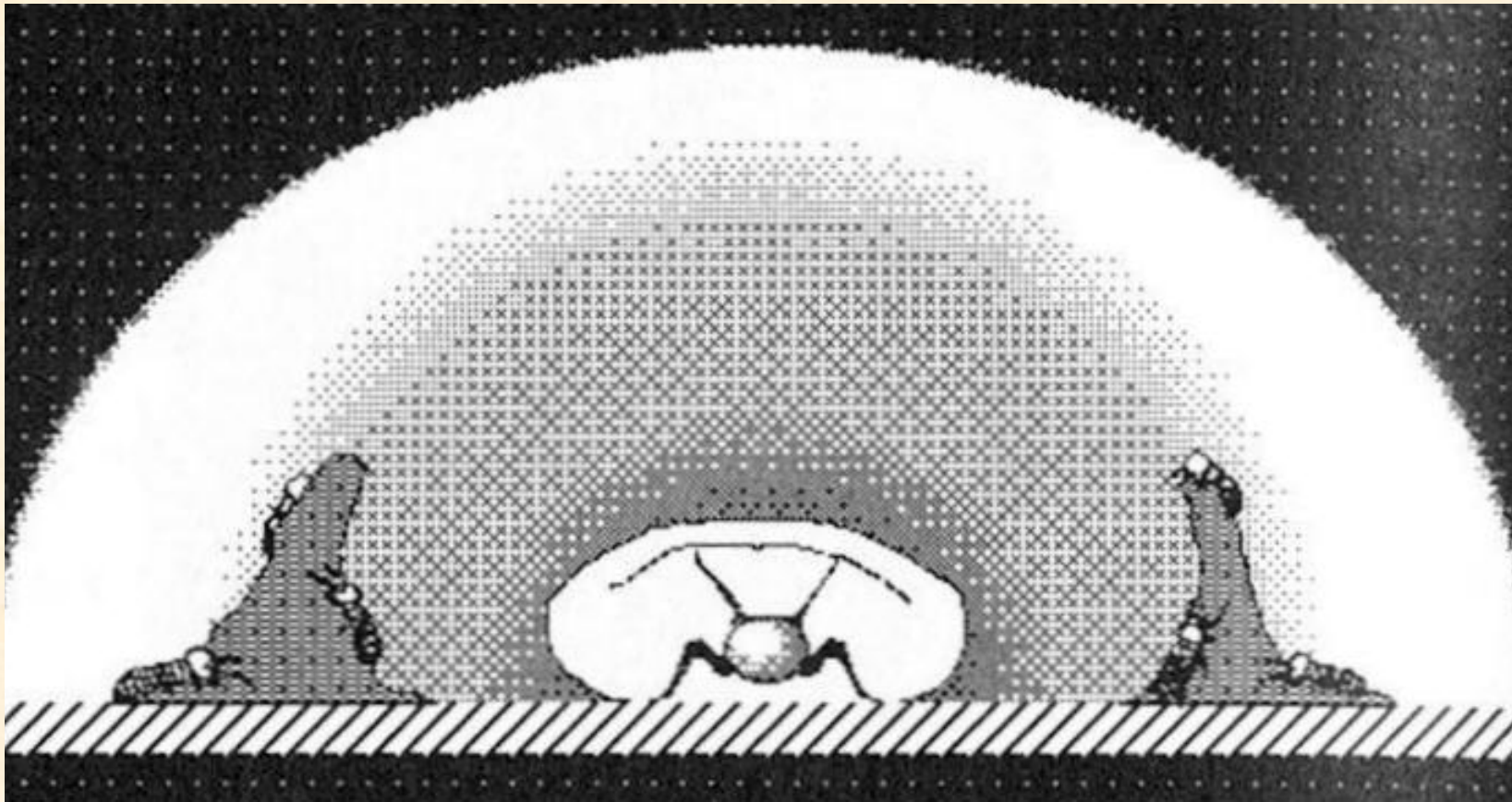

2013/4/12

Fig. from Bonabeau, Dorigo & Theraulaz

14

Construction of Arch (3)

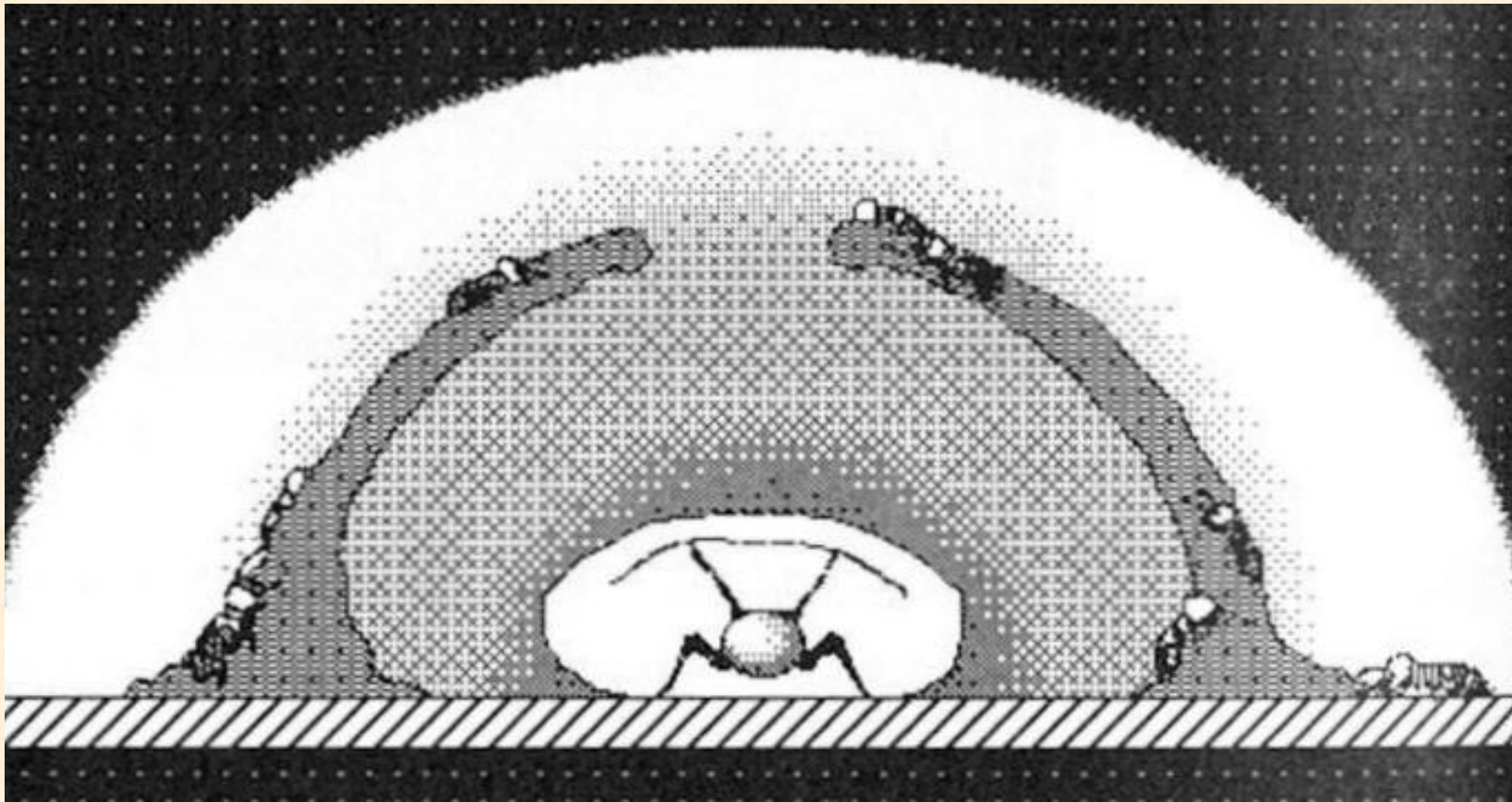

2013/4/12

Fig. from Bonabeau, Dorigo & Theraulaz

15

Basic Principles

- Continuous (quantitative) stigmergy
- Positive feedback:
 - via pheromone deposition
- Negative feedback:
 - depletion of soil granules & competition between pillars
 - pheromone decay

Deneubourg Model

- $H(r, t)$ = concentration of cement pheromone in air at location r & time t
- $P(r, t)$ = amount of deposited cement with still active pheromone at r, t
- $C(r, t)$ = density of laden termites at r, t
- Φ = constant flow of laden termites into system

Equation for P (Deposited Cement with Pheromone)

$\partial_t P$ (rate of change of active cement) =
 $k_1 C$ (rate of cement deposition by termites)
 $- k_2 P$ (rate of pheromone loss to air)

$$\partial_t P = k_1 C - k_2 P$$

Equation for H

(Concentration of Pheromone)

$\partial_t H$ (rate of change of concentration) =
 $k_2 P$ (pheromone from deposited material)
 $- k_4 H$ (pheromone decay)
 $+ D_H \nabla^2 H$ (pheromone diffusion)

$$\partial_t H = k_2 P - k_4 H + D_H \nabla^2 H$$

Equation for C

(Density of Laden Termites)

$\partial_t C$ (rate of change of concentration) =
 Φ (flux of laden termites)
 $- k_1 C$ (unloading of termites)
 $+ D_C \nabla^2 C$ (random walk)
 $- \gamma \nabla \cdot (C \nabla H)$ (chemotaxis: response to pheromone gradient)

$$\partial_t C = \Phi - k_1 C + D_C \nabla^2 C - \gamma \nabla \cdot (C \nabla H)$$

Explanation of Divergence

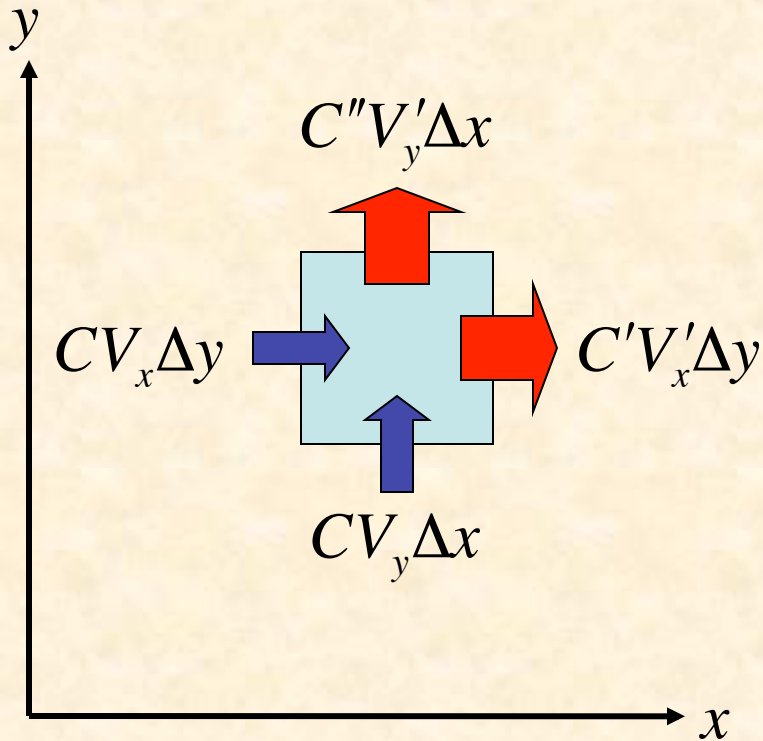

- velocity field = $\mathbf{V}(x,y)$
 $= \mathbf{i}V_x(x,y) + \mathbf{j}V_y(x,y)$
- $C(x,y)$ = density
- outflow rate =
 $\Delta_x(CV_x) \Delta y + \Delta_y(CV_y) \Delta x$
- outflow rate / unit area

$$= \frac{\Delta_x(CV_x)}{\Delta x} + \frac{\Delta_y(CV_y)}{\Delta y}$$

$$\rightarrow \frac{\partial(CV_x)}{\partial x} + \frac{\partial(CV_y)}{\partial y} = \nabla \cdot C\mathbf{V}$$

Explanation of Chemotaxis Term

- The termite flow *into* a region is the *negative* divergence of the flux through it
$$-\nabla \cdot \mathbf{J} = -(\partial J_x / \partial x + \partial J_y / \partial y)$$
- The flux velocity is proportional to the pheromone gradient
$$\mathbf{J} \propto \nabla H$$
- The flux density is proportional to the number of moving termites
$$\mathbf{J} \propto C$$
- Hence, $-\gamma \nabla \cdot \mathbf{J} = -\gamma \nabla \cdot (C \nabla H)$

Simulation ($T = 0$)

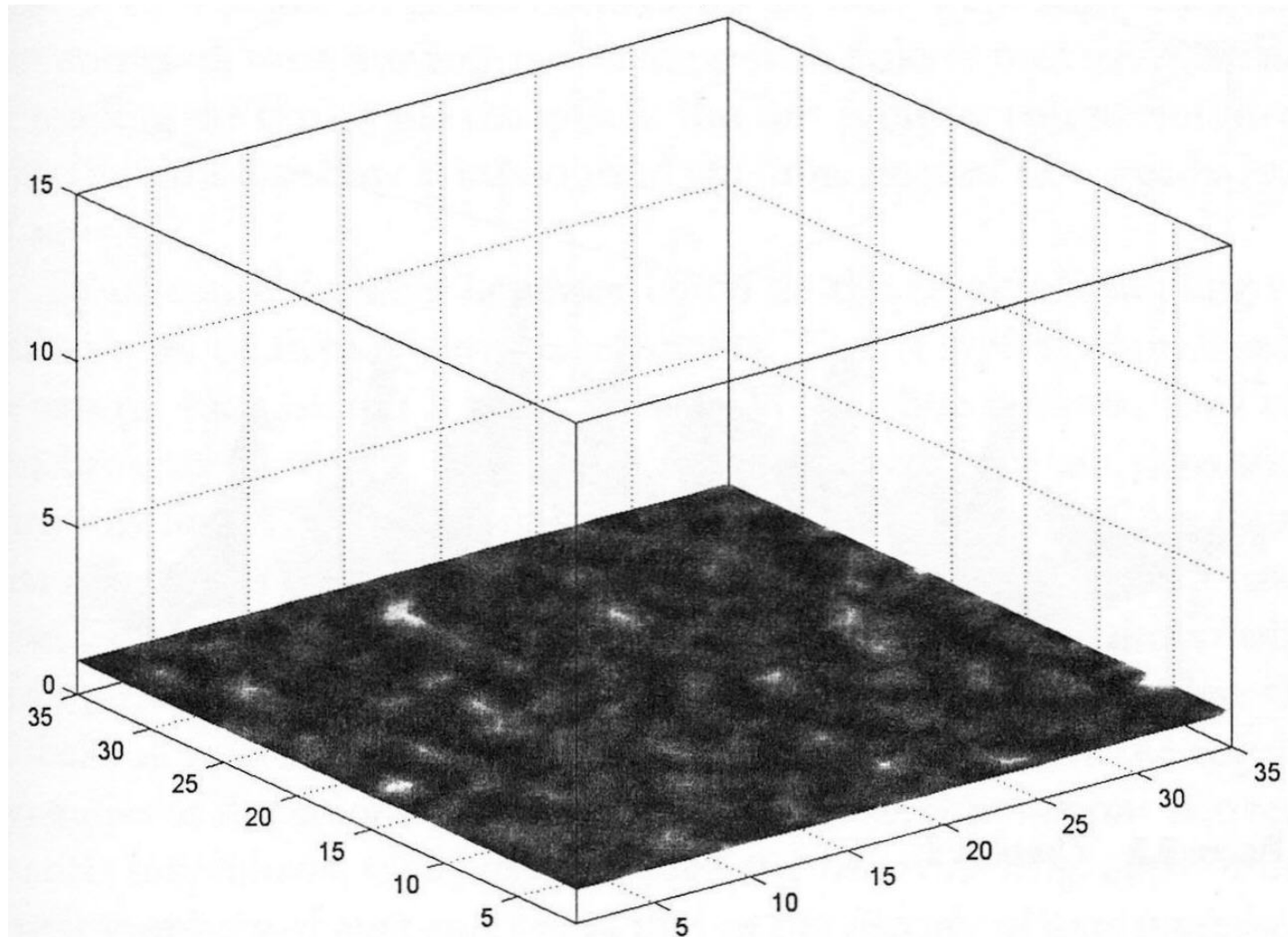

2013/4/12

fig. from Solé & Goodwin

23

Simulation ($T = 100$)

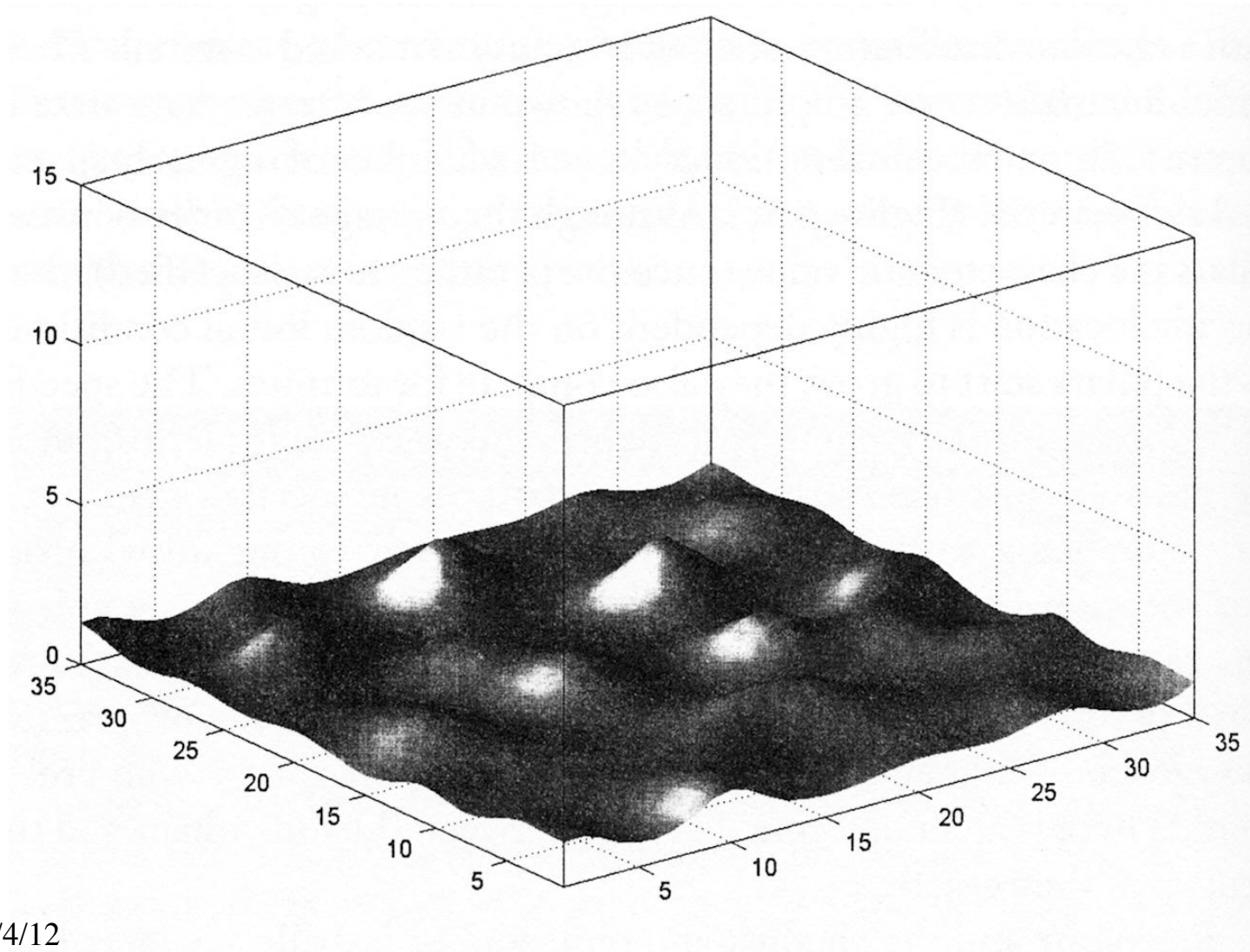

2013/4/12

fig. from Solé & Goodwin

24

Simulation ($T = 1000$)

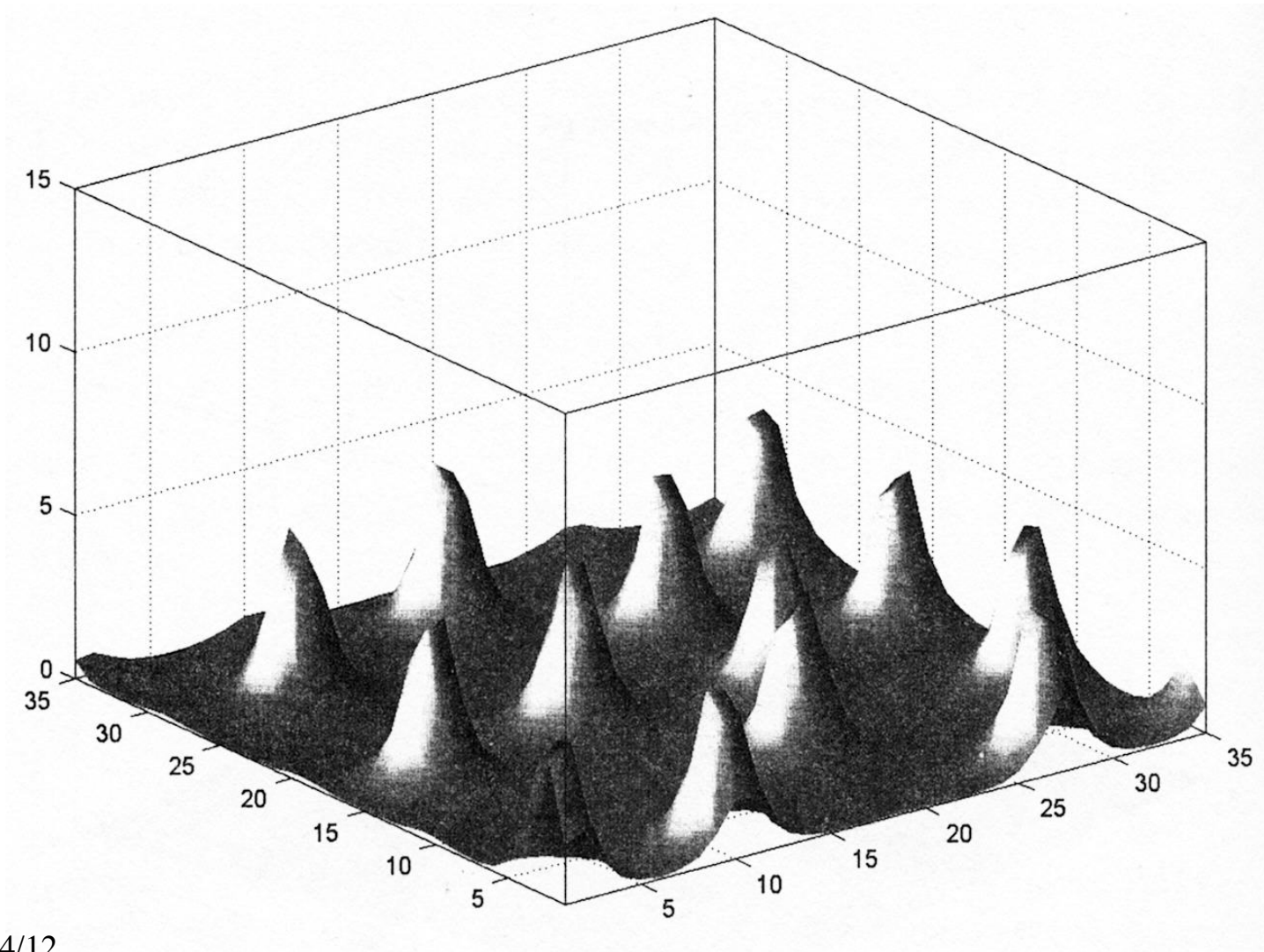

2013/4/12

fig. from Solé & Goodwin

25

Conditions for Self-Organized Pillars

- Will not produce regularly spaced pillars if:
 - density of termites is too low
 - rate of deposition is too low
- A homogeneous stable state results

$$C_0 = \frac{\Phi}{k_1}, \quad H_0 = \frac{\Phi}{k_4}, \quad P_0 = \frac{\Phi}{k_2}$$

NetLogo Simulation of Deneubourg Model

[Run Pillars3D.nlogo](#)

Interaction of Three Pheromones

- Queen pheromone governs size and shape of queen chamber (template)
- Cement pheromone governs construction and spacing of pillars & arches (stigmergy)
- Trail pheromone:
 - attracts workers to construction sites (stigmergy)
 - encourages soil pickup (stigmergy)
 - governs sizes of galleries (template)

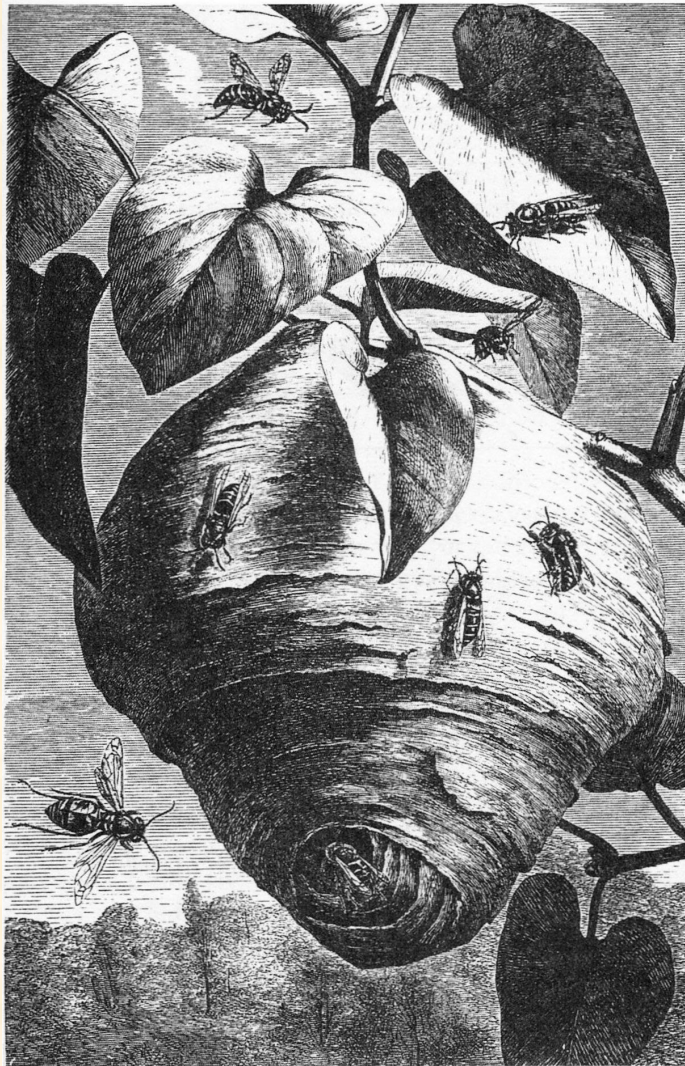

Wasp Nest Building and Discrete Stigmergy

2013/4/12

Fig. from Solé & Goodwin

29

Structure of Some Wasp Nests

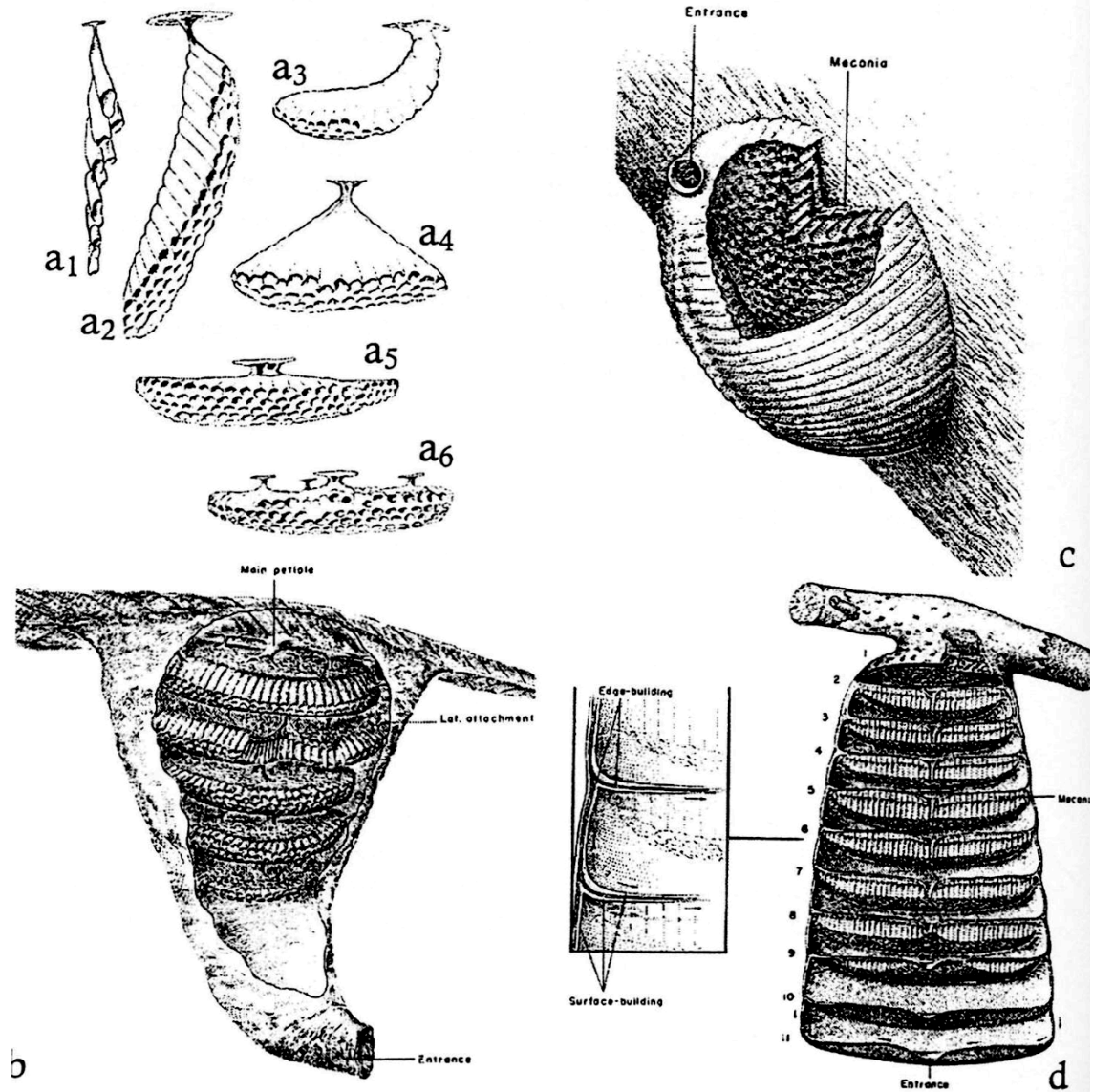

2013/4/12

Fig. from *Self-Org. Biol. Sys.*

30

Adaptive Function of Nests

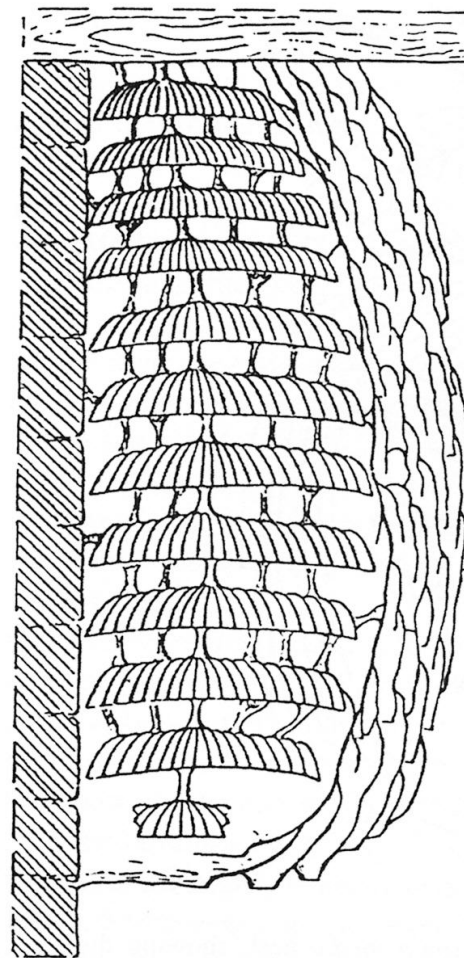

How Do They Do It?



2013/4/12

32

Lattice Swarms

(developed by Theraulaz & Bonabeau)

Discrete vs. Continuous Stigmergy

- Recall: *stigmergy* is the coordination of activities through the environment
- *Continuous* or *quantitative* stigmergy
 - quantitatively different stimuli trigger quantitatively different behaviors
- *Discrete* or *qualitative* stigmergy
 - stimuli are classified into distinct classes, which trigger distinct behaviors

Discrete Stigmergy in Comb Construction

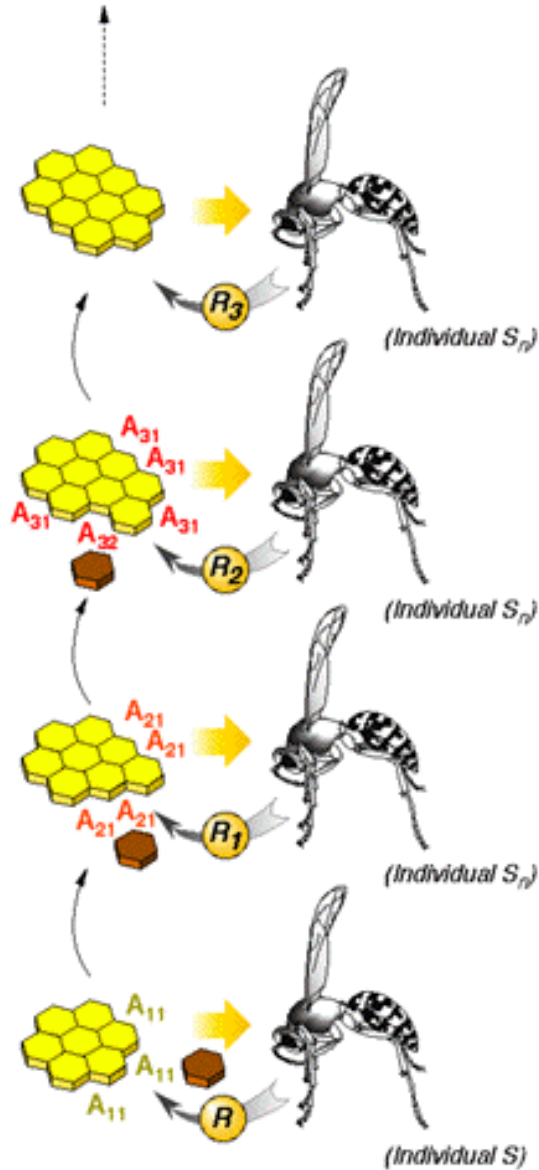

- Initially all sites are equivalent
- After addition of cell, qualitatively different sites created

Numbers and Kinds of Building Sites

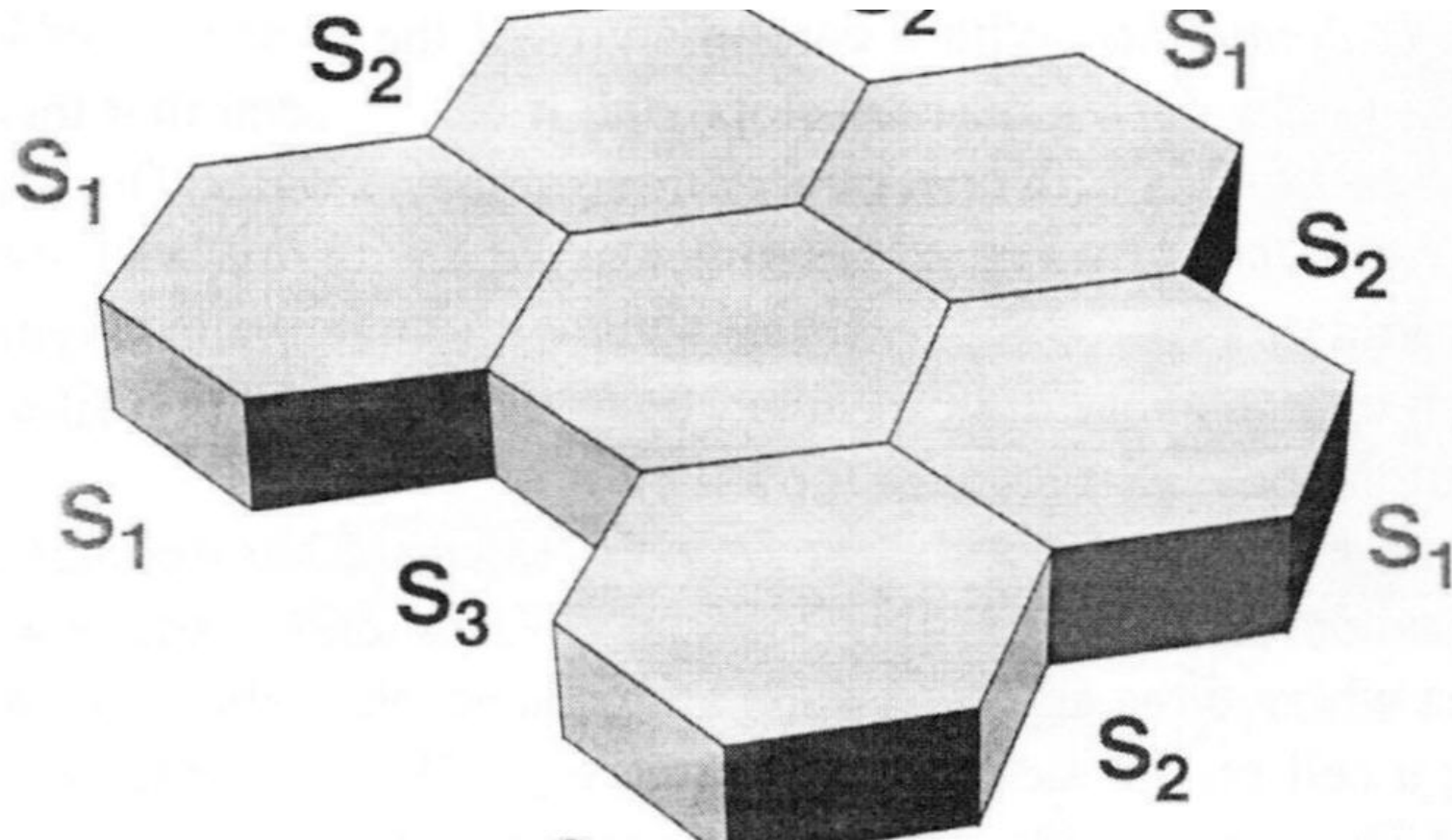

Lattice Swarm Model

- Random movement by wasps in a 3D lattice
 - cubic or hexagonal
- Wasps obey a 3D CA-like rule set
- Depending on configuration, wasp deposits one of several types of “bricks”
- Once deposited, it cannot be removed
- May be deterministic or probabilistic
- Start with a single brick

Cubic Neighborhood

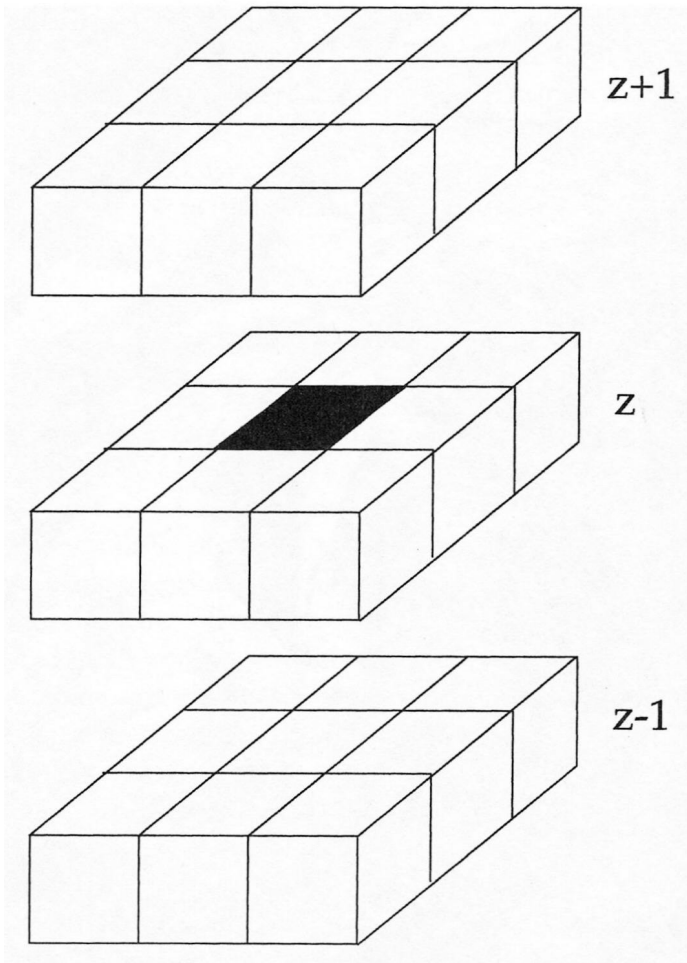

- Deposited brick depends on states of 26 surrounding cells
- Configuration of surrounding cells may be represented by matrices:

$$\begin{bmatrix} 0 & 0 & 0 \\ 1 & 0 & 0 \\ 0 & 0 & 0 \end{bmatrix} \times \begin{bmatrix} 0 & 0 & 0 \\ 1 & \bullet & 0 \\ 0 & 0 & 0 \end{bmatrix} \times \begin{bmatrix} 0 & 0 & 0 \\ 1 & 0 & 0 \\ 0 & 0 & 0 \end{bmatrix}$$

Hexagonal Neighborhood

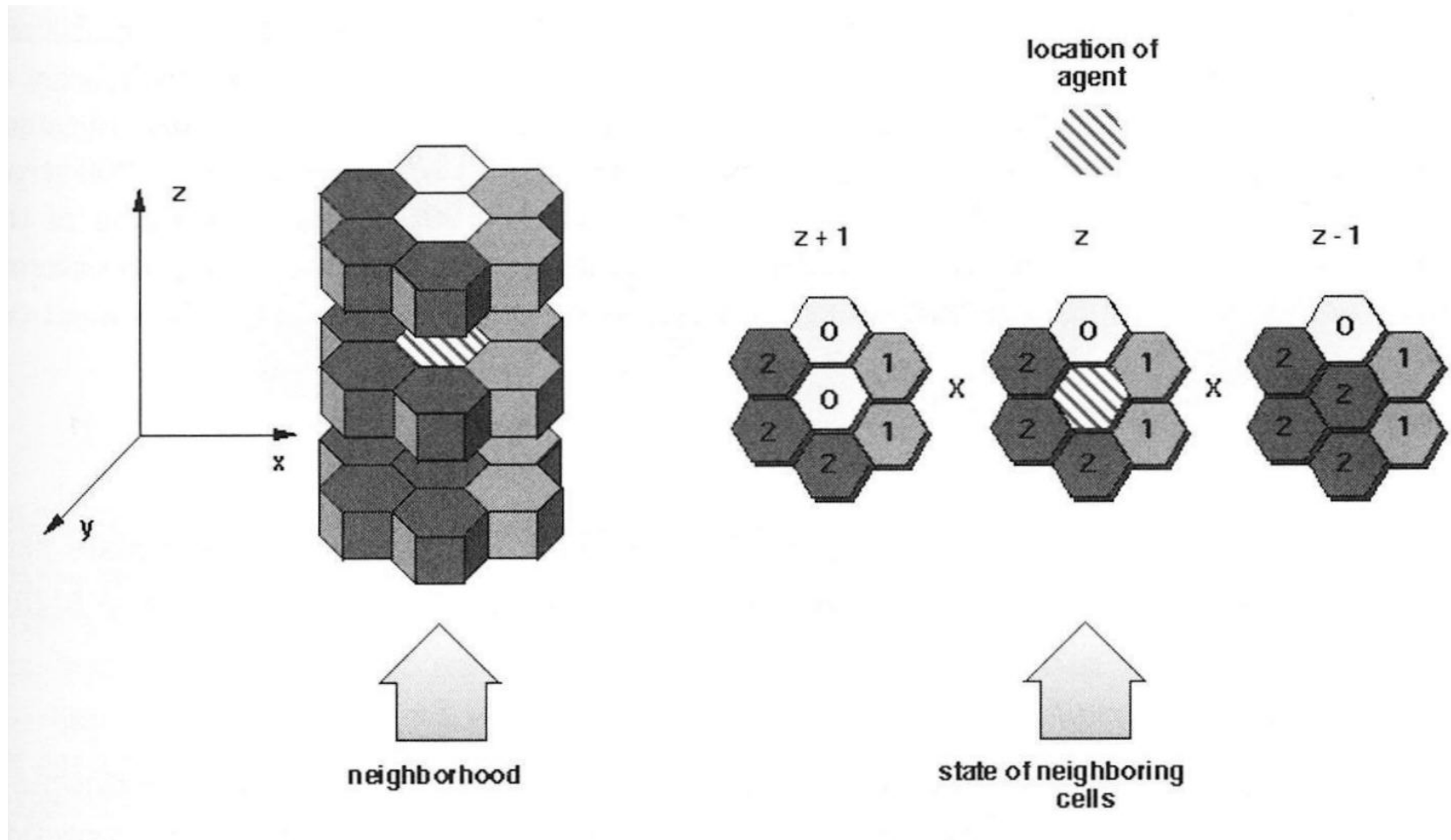

Example Construction

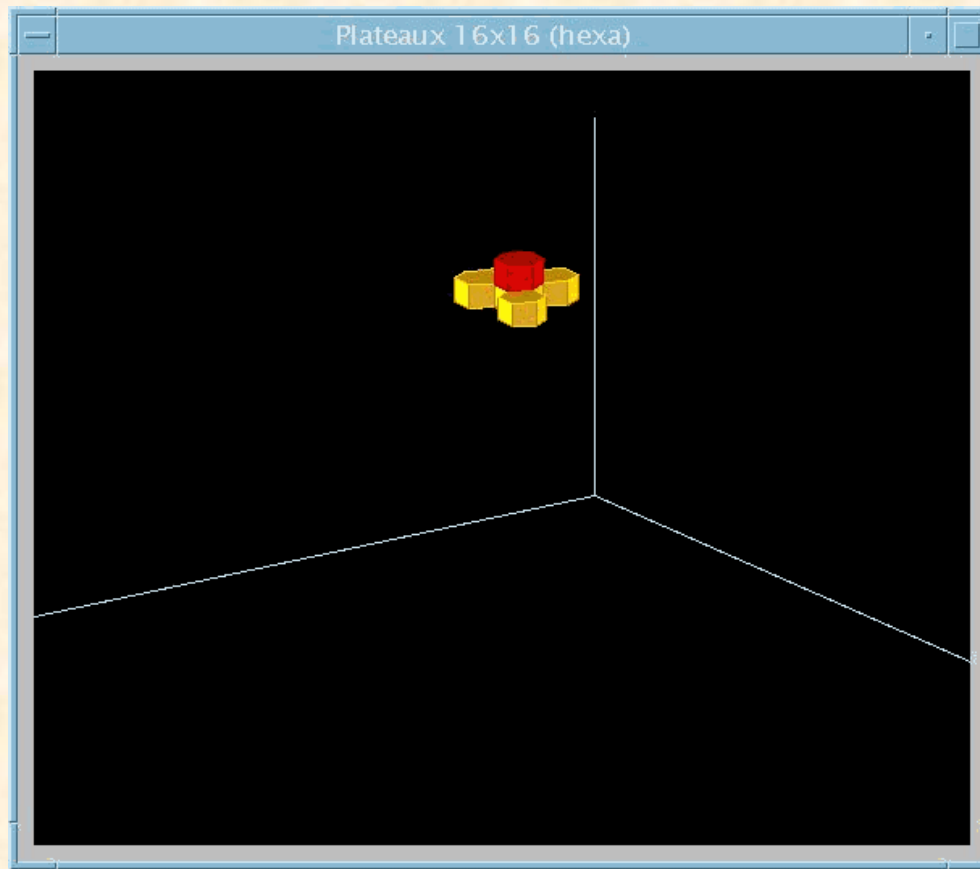

Another Example

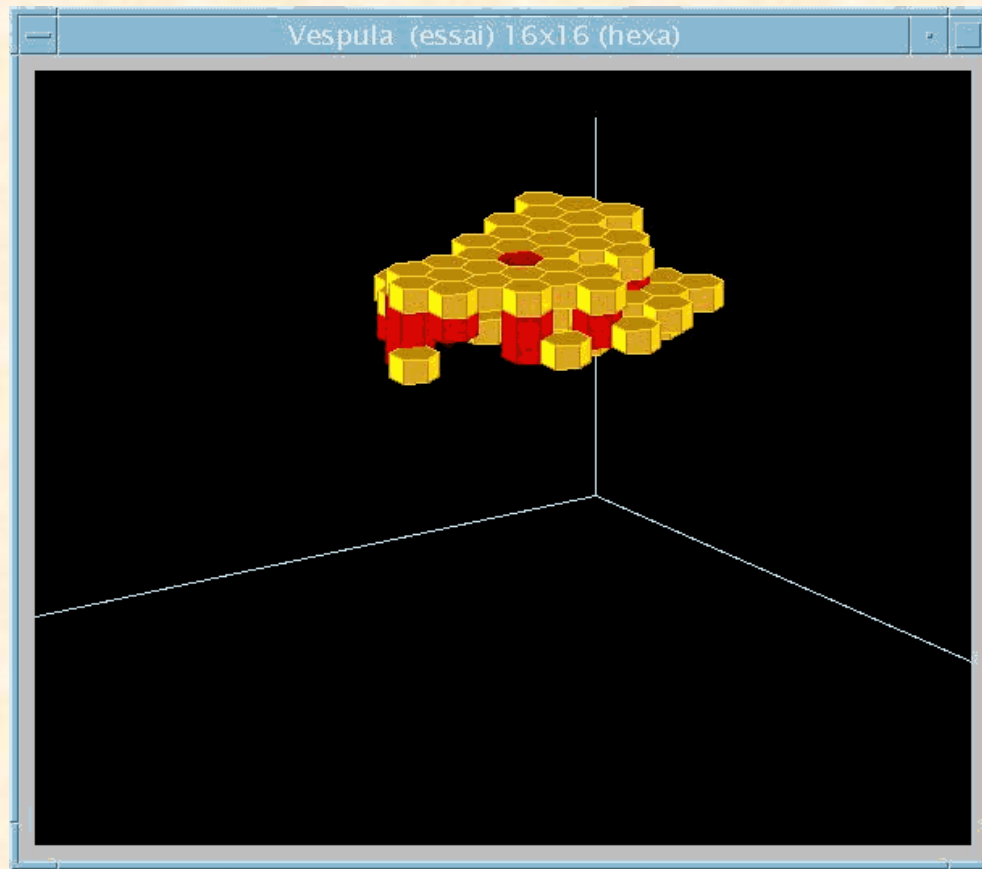

A Simple Pair of Rules

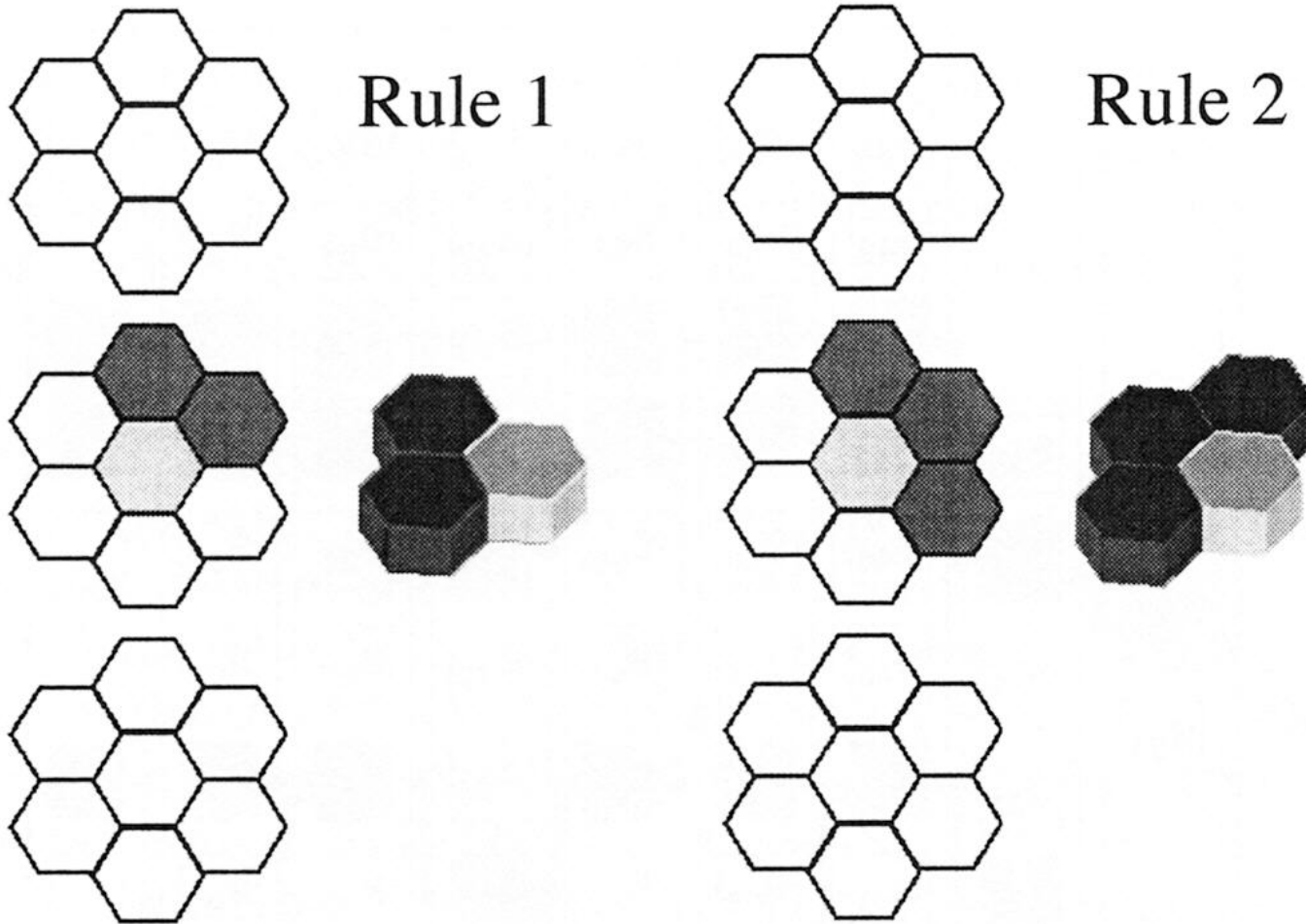

Result from Deterministic Rules

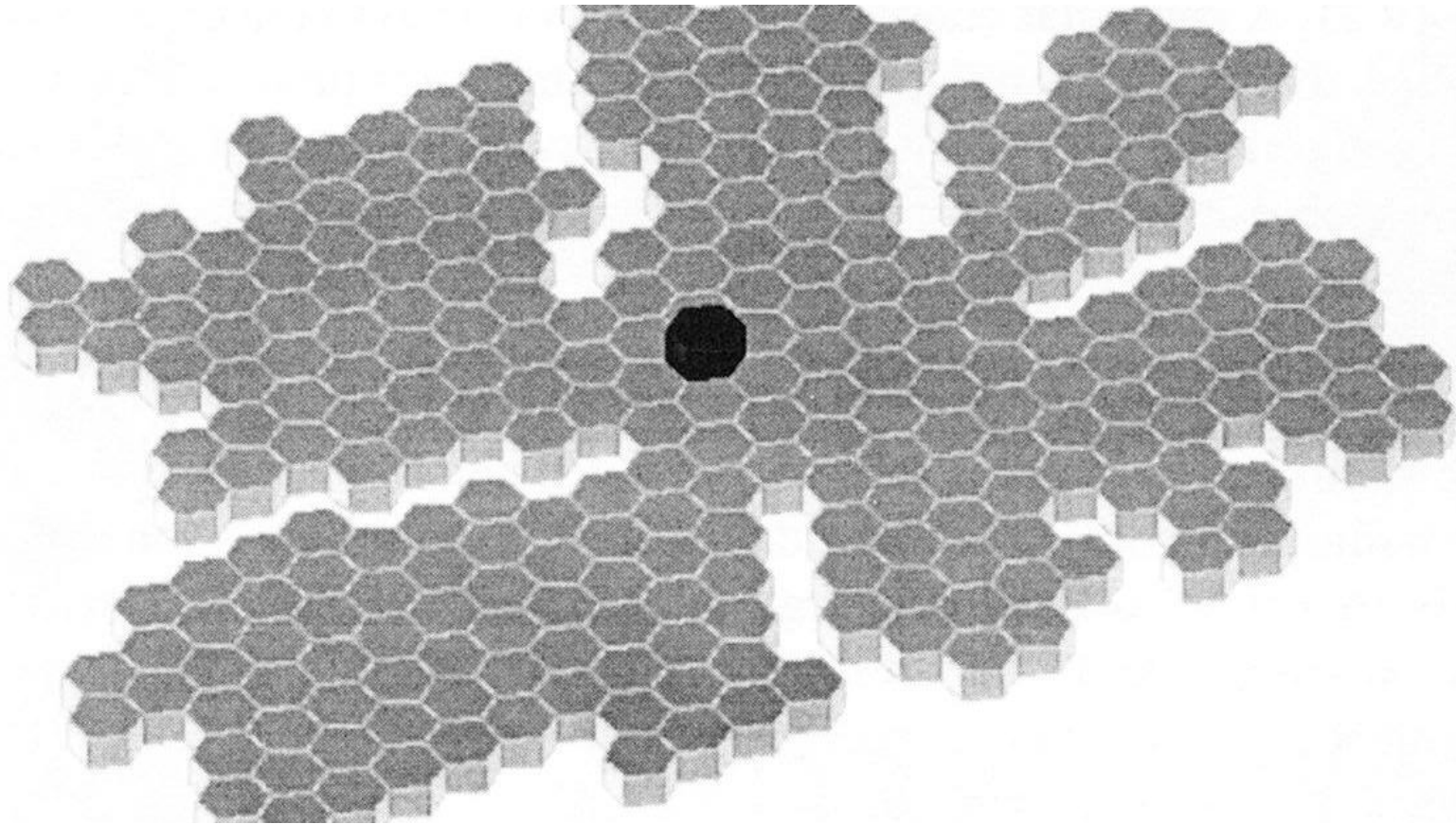

2013/4/12

Fig. from *Self-Org. in Biol. Sys.*

43

Result from Probabilistic Rules

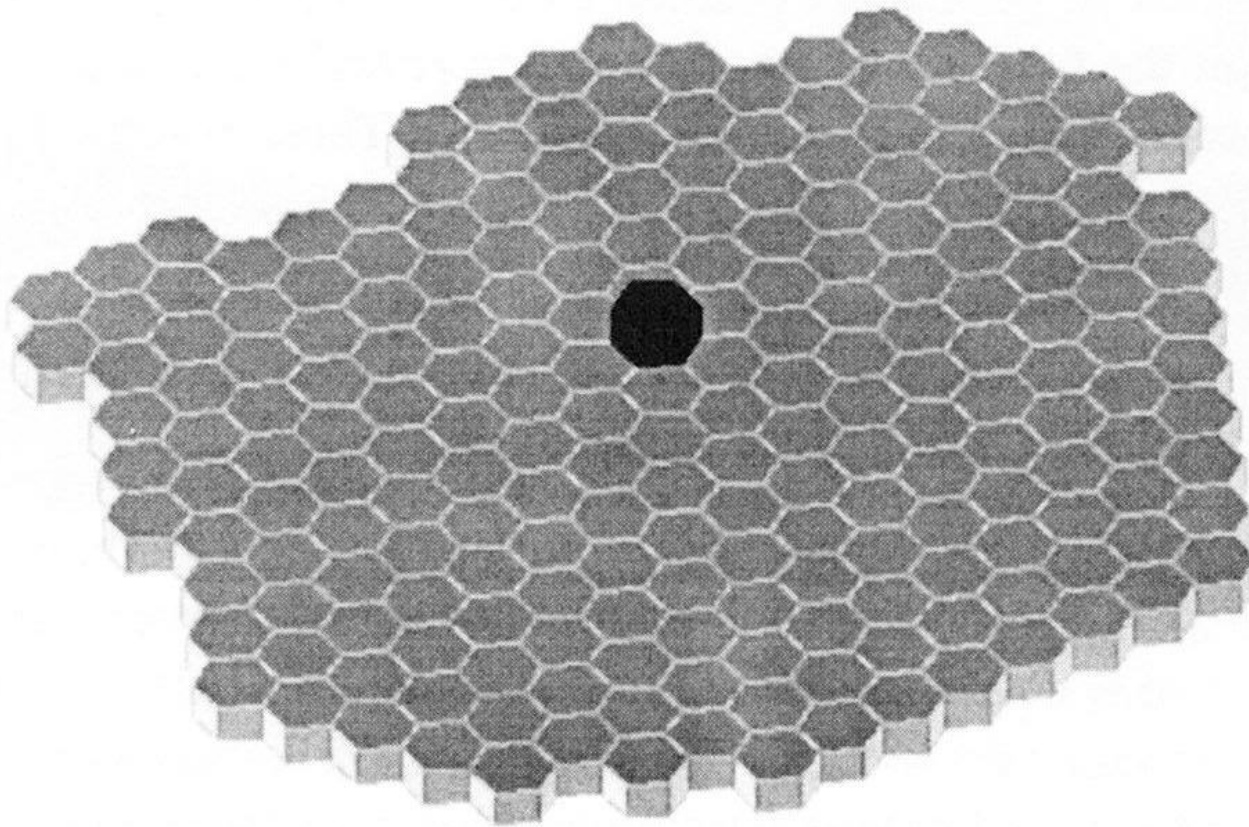

b

2013/4/12

Fig. from *Self-Org. in Biol. Sys.*

44

Example Rules for a More Complex Architecture

The following stimulus configurations cause the agent to deposit a type-1 brick:

$$(1.1) \quad \begin{bmatrix} 0 & 0 & 0 \\ 0 & 1 & 0 \\ 0 & 0 & 0 \end{bmatrix} \times \begin{bmatrix} 0 & 0 & 0 \\ 0 & \bullet & 0 \\ 0 & 0 & 0 \end{bmatrix} \times \begin{bmatrix} 0 & 0 & 0 \\ 0 & 0 & 0 \\ 0 & 0 & 0 \end{bmatrix}$$

$$(1.2) \quad \begin{bmatrix} 0 & 0 & 0 \\ 1 & 0 & 0 \\ 0 & 0 & 0 \end{bmatrix} \times \begin{bmatrix} 0 & 0 & 0 \\ 1 & \bullet & 0 \\ 0 & 0 & 0 \end{bmatrix} \times \begin{bmatrix} 0 & 0 & 0 \\ 1 & 0 & 0 \\ 0 & 0 & 0 \end{bmatrix}$$

Result

- $20 \times 20 \times 20$ lattice
- 10 wasps
- After 20 000 simulation steps
- Axis and plateaus
- Resembles nest of *Parachartergus*



Architectures Generated from Other Rule Sets

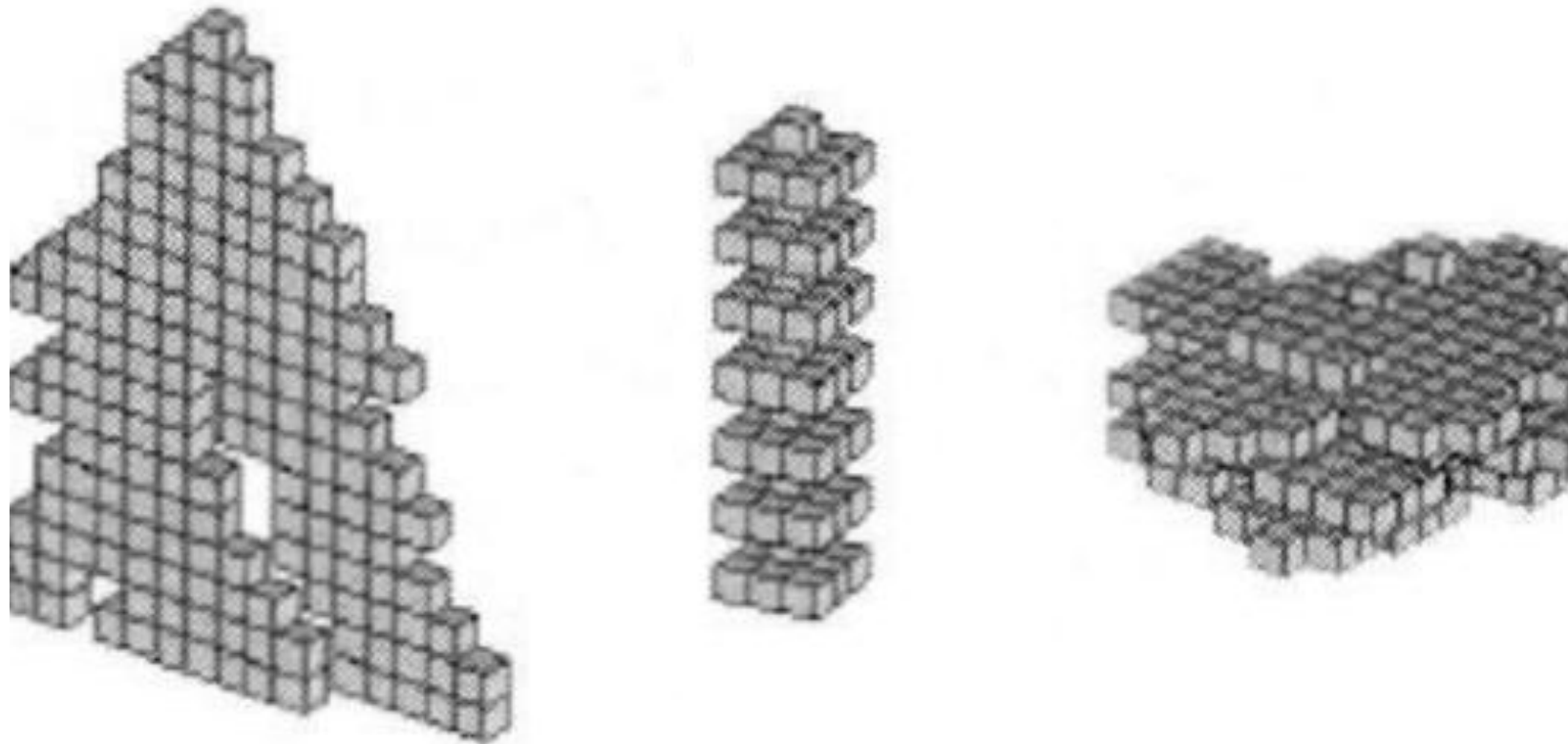

More Cubic Examples

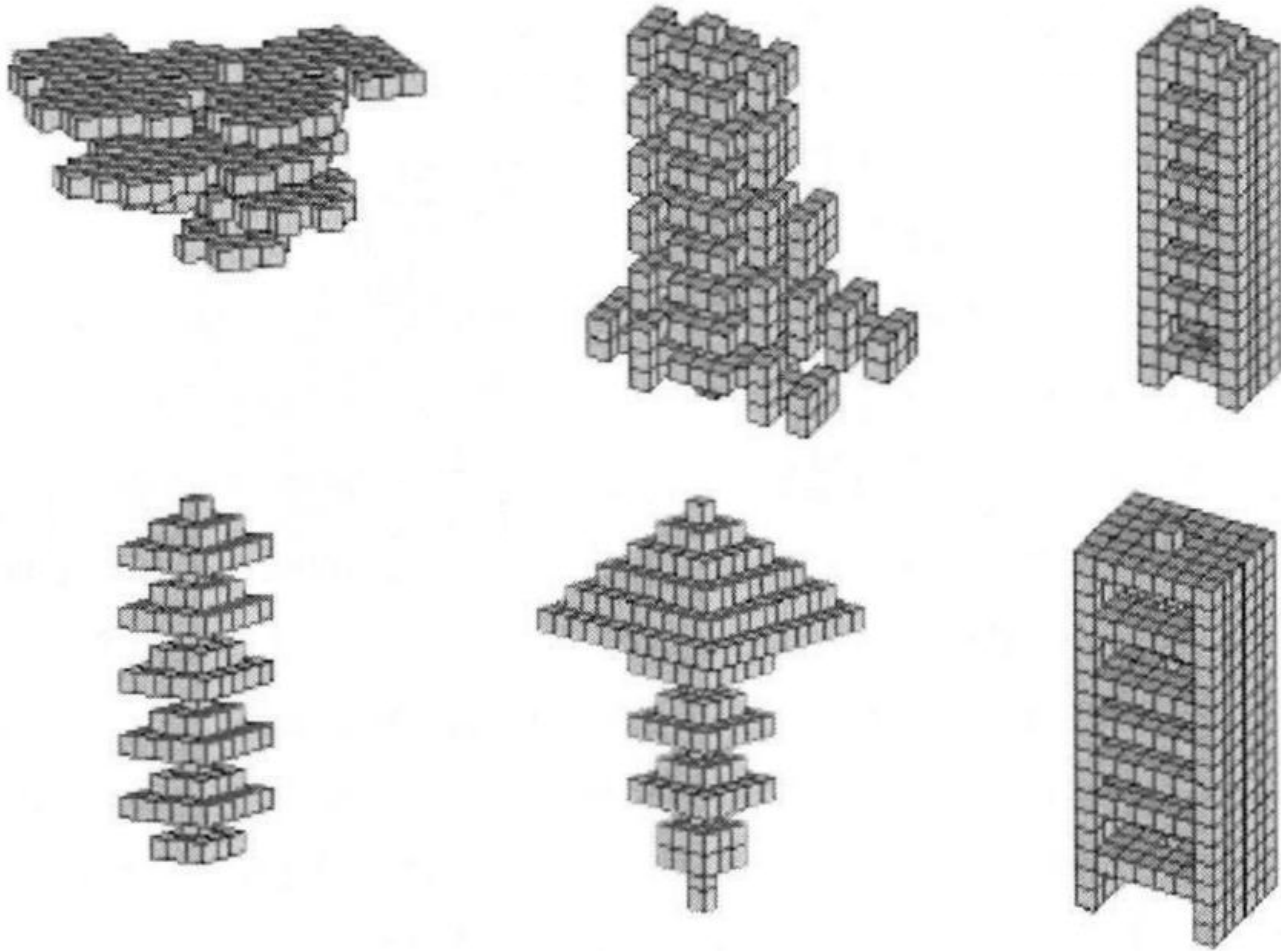

Cubic Examples (1)

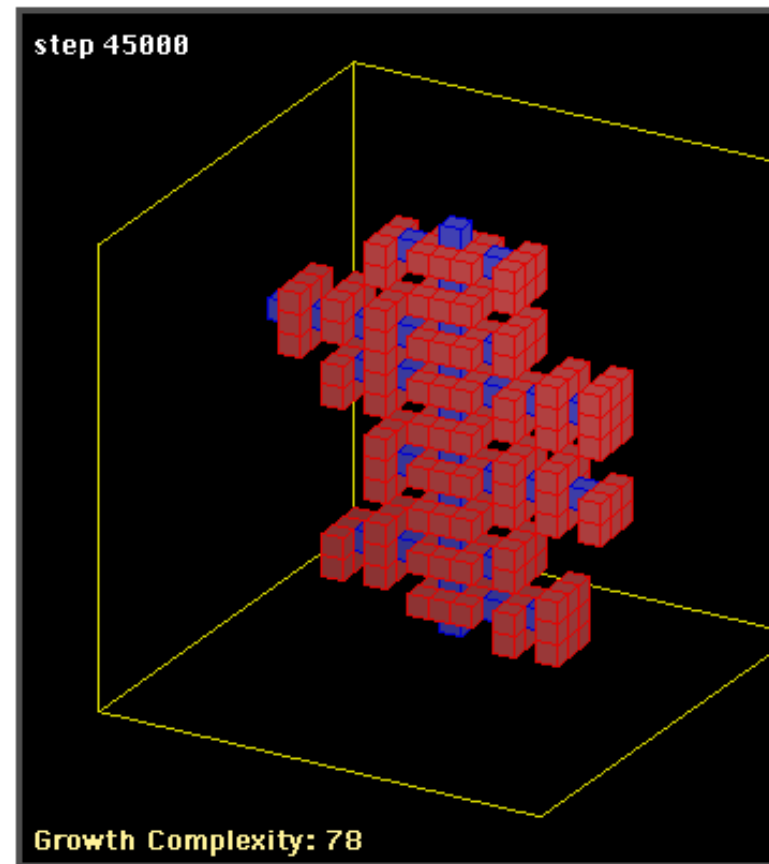
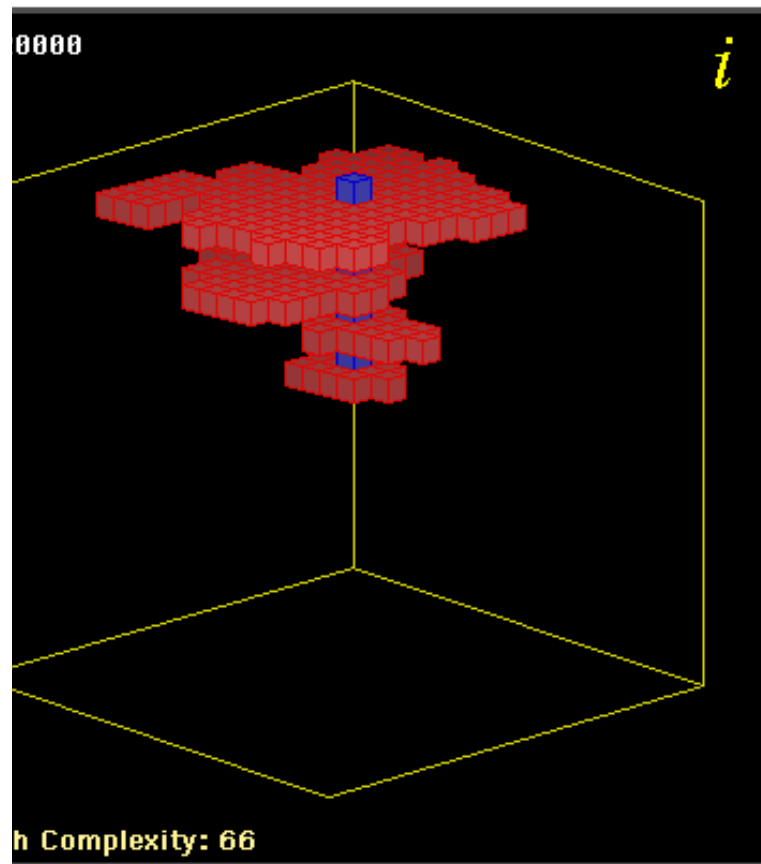

Cubic Examples (2)

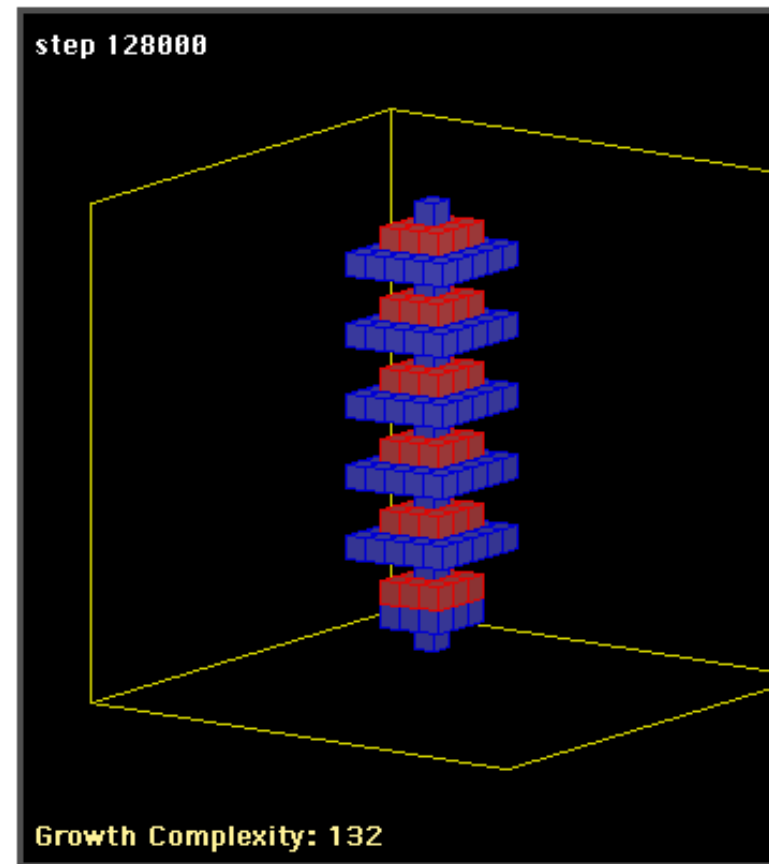
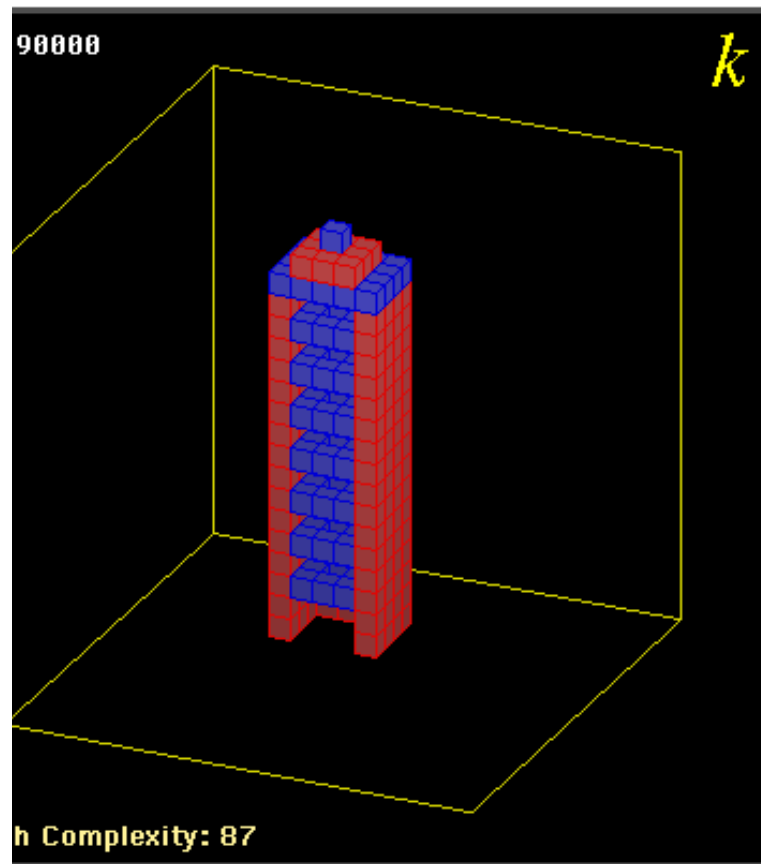

Cubic Examples (3)

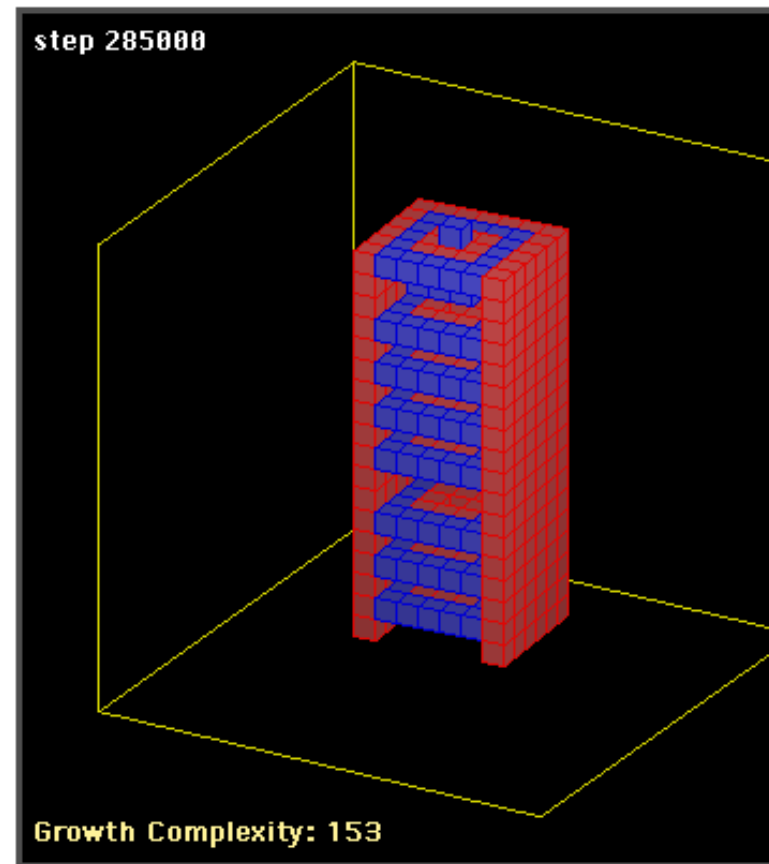
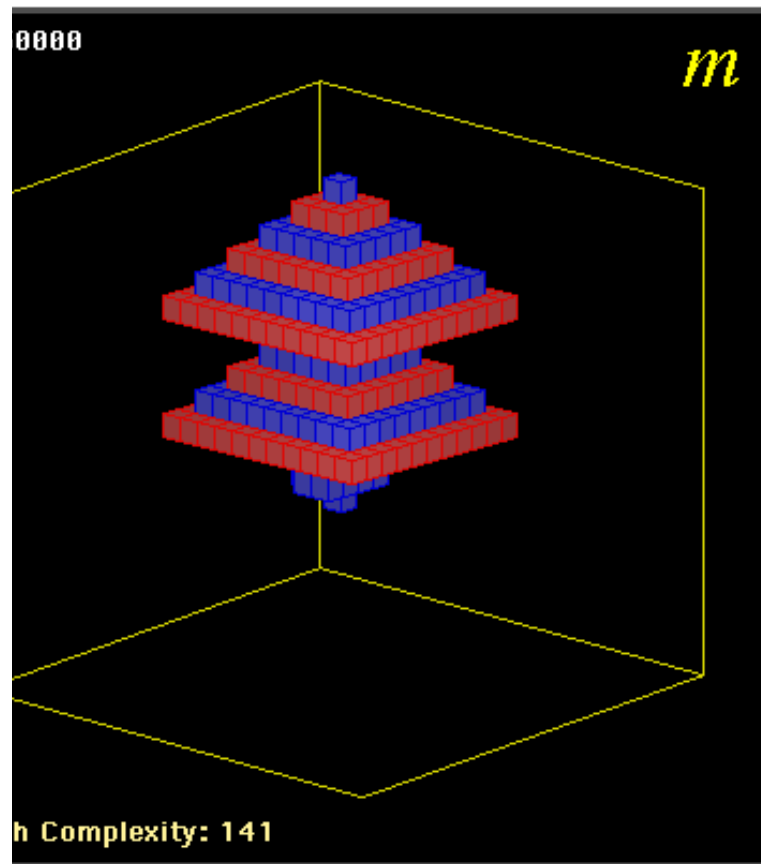

Cubic Examples (4)

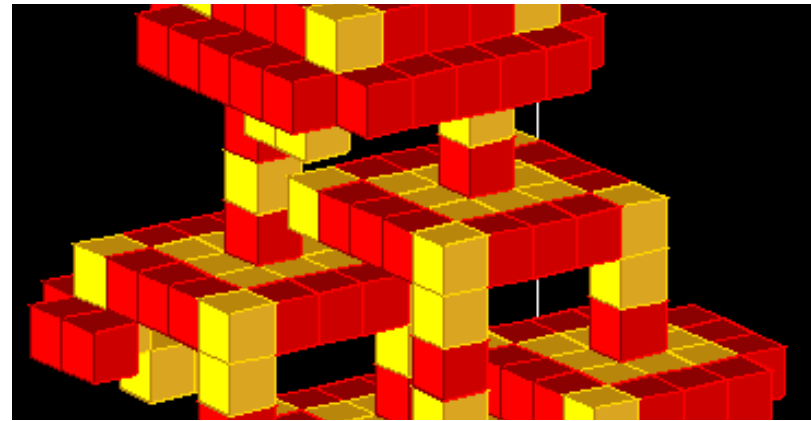
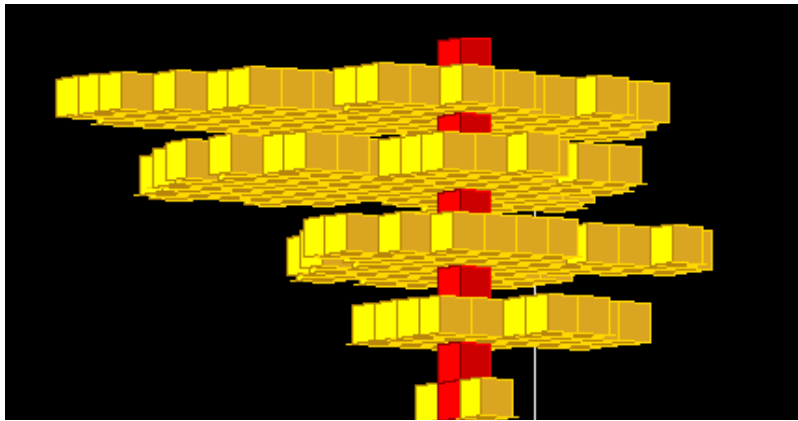

Cubic Examples (5)

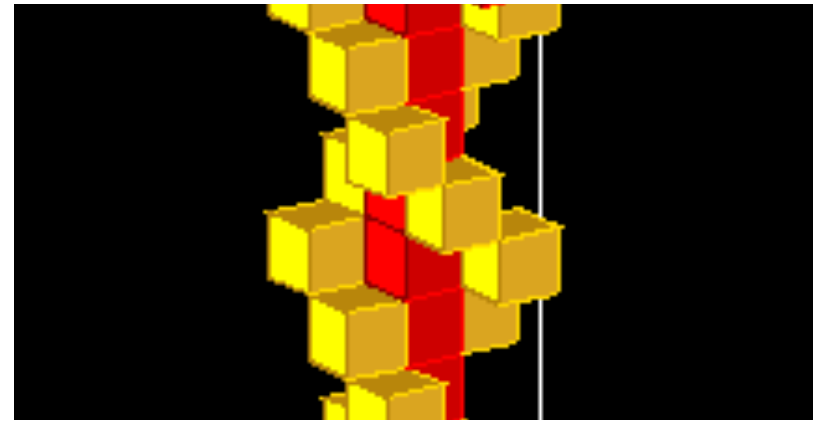
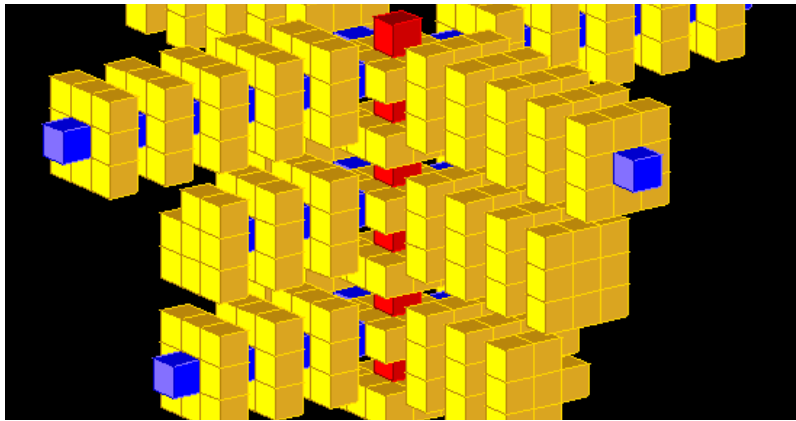

An Interesting Example

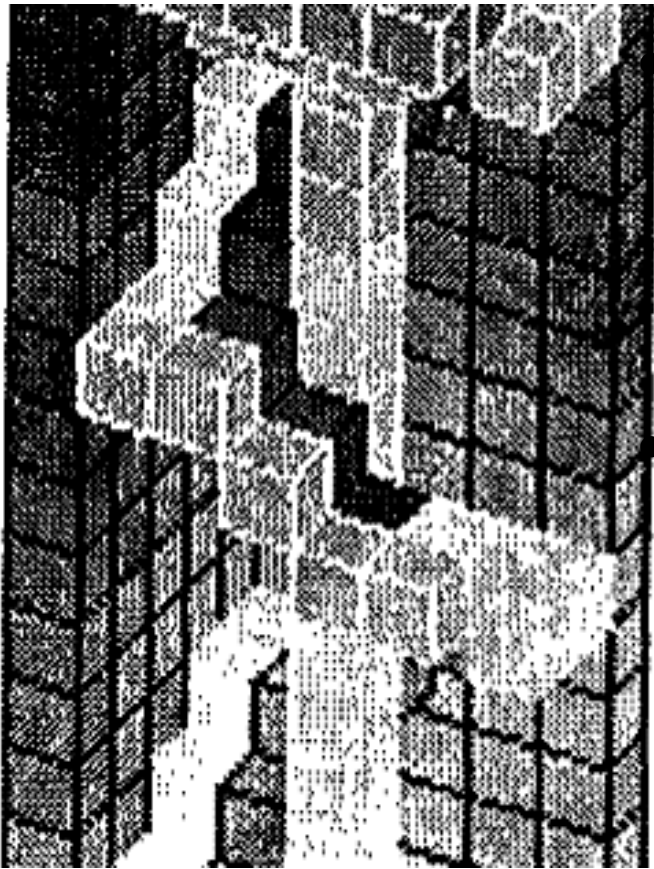

Includes

- central axis
- external envelope
- long-range helical ramp

Similar to *Apicotermes*
termite nest

Similar Results with Hexagonal Lattice

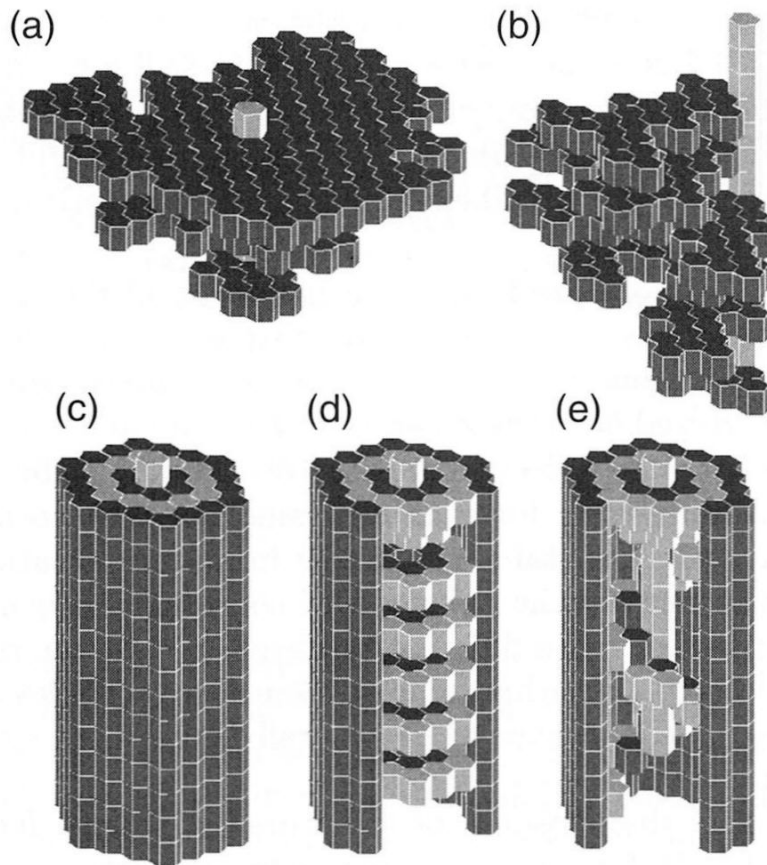

- $20 \times 20 \times 20$ lattice
- 10 wasps
- All resemble nests of wasp species
- (d) is (c) with envelope cut away
- (e) has envelope cut away

More Hexagonal Examples

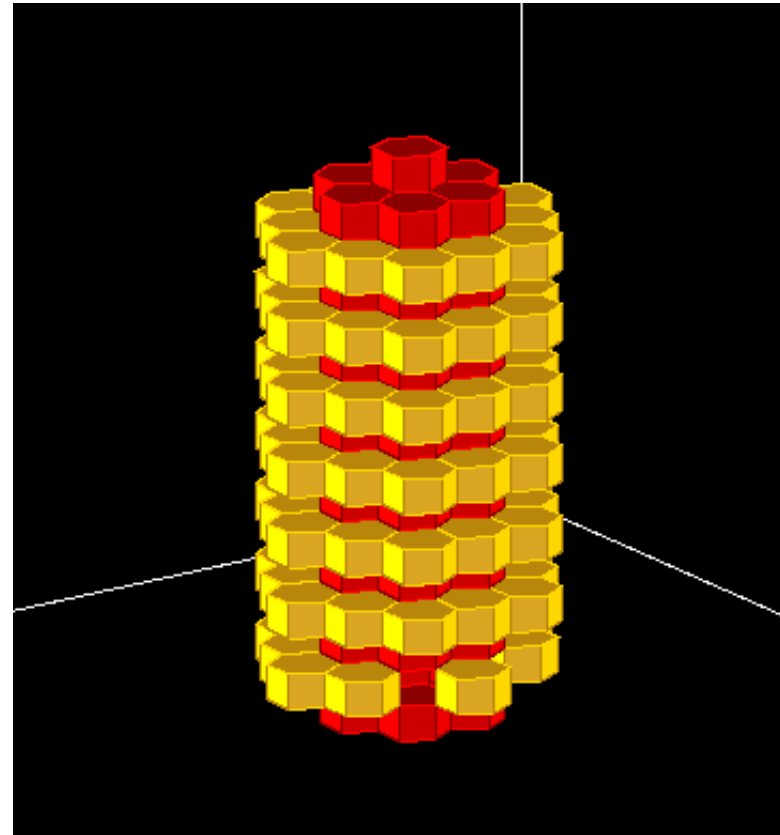
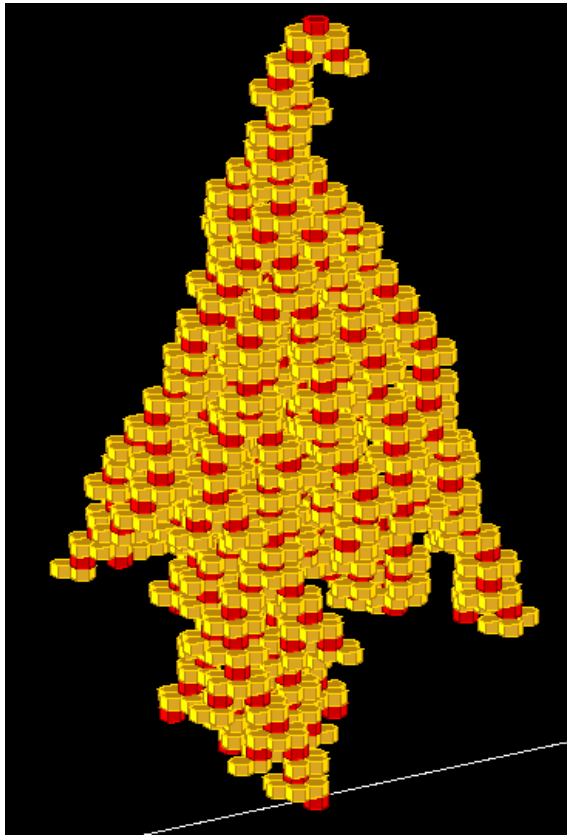

Effects of Randomness (Coordinated Algorithm)



- Specifically different (i.e., different in details)
- Generically the same (qualitatively identical)
- Sometimes results are fully constrained

Effects of Randomness (Non-coordinated Algorithm)

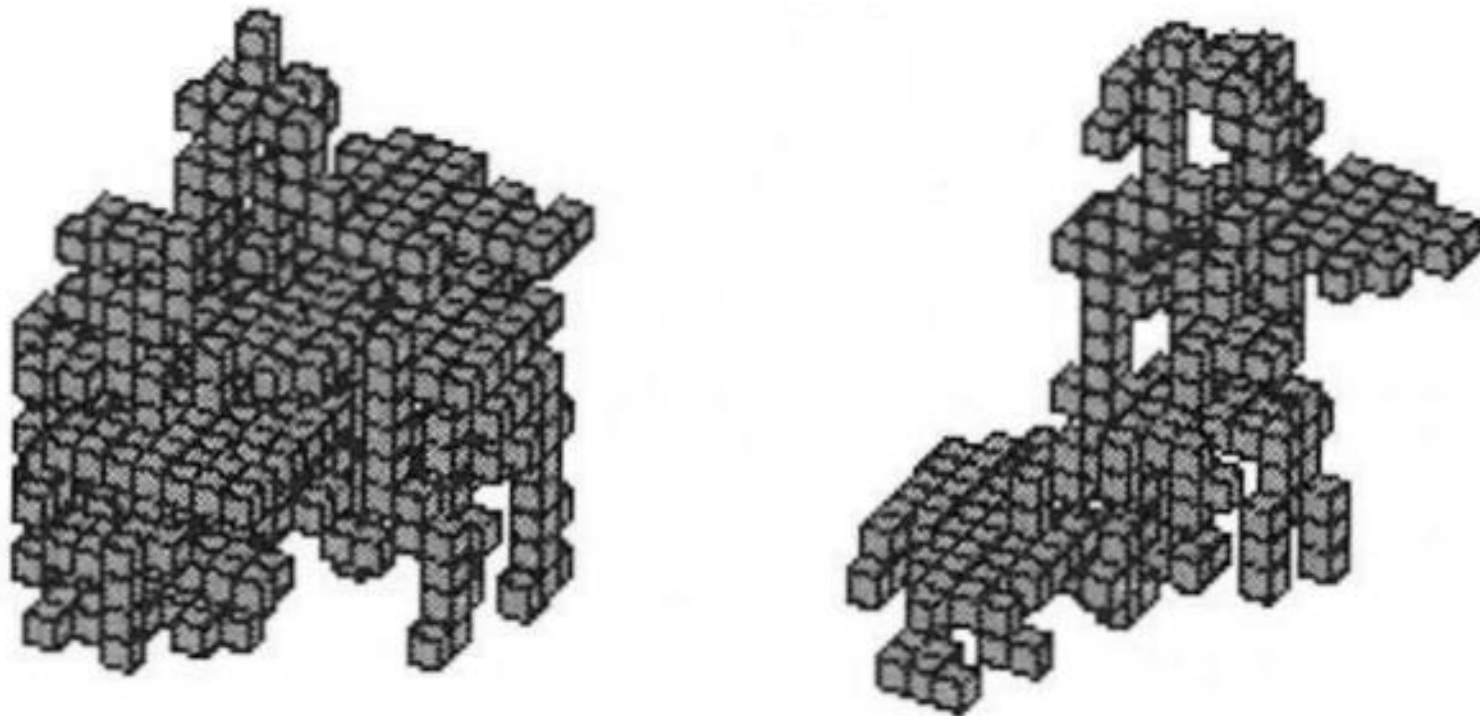

Non-coordinated Algorithms

- Stimulating configurations are not ordered in time and space
- Many of them overlap
- Architecture grows without any coherence
- May be convergent, but are still unstructured

Coordinated Algorithm

- Non-conflicting rules
 - can't prescribe two different actions for the same configuration
- Stimulating configurations for different building stages cannot overlap
- At each stage, “handshakes” and “interlocks” are required to prevent conflicts in parallel assembly

More Formally...

- Let $C = \{c_1, c_2, \dots, c_n\}$ be the set of local stimulating configurations
- Let (S_1, S_2, \dots, S_m) be a sequence of assembly stages
- These stages partition C into mutually disjoint subsets $C(S_p)$
- Completion of S_p signaled by appearance of a configuration in $C(S_{p+1})$

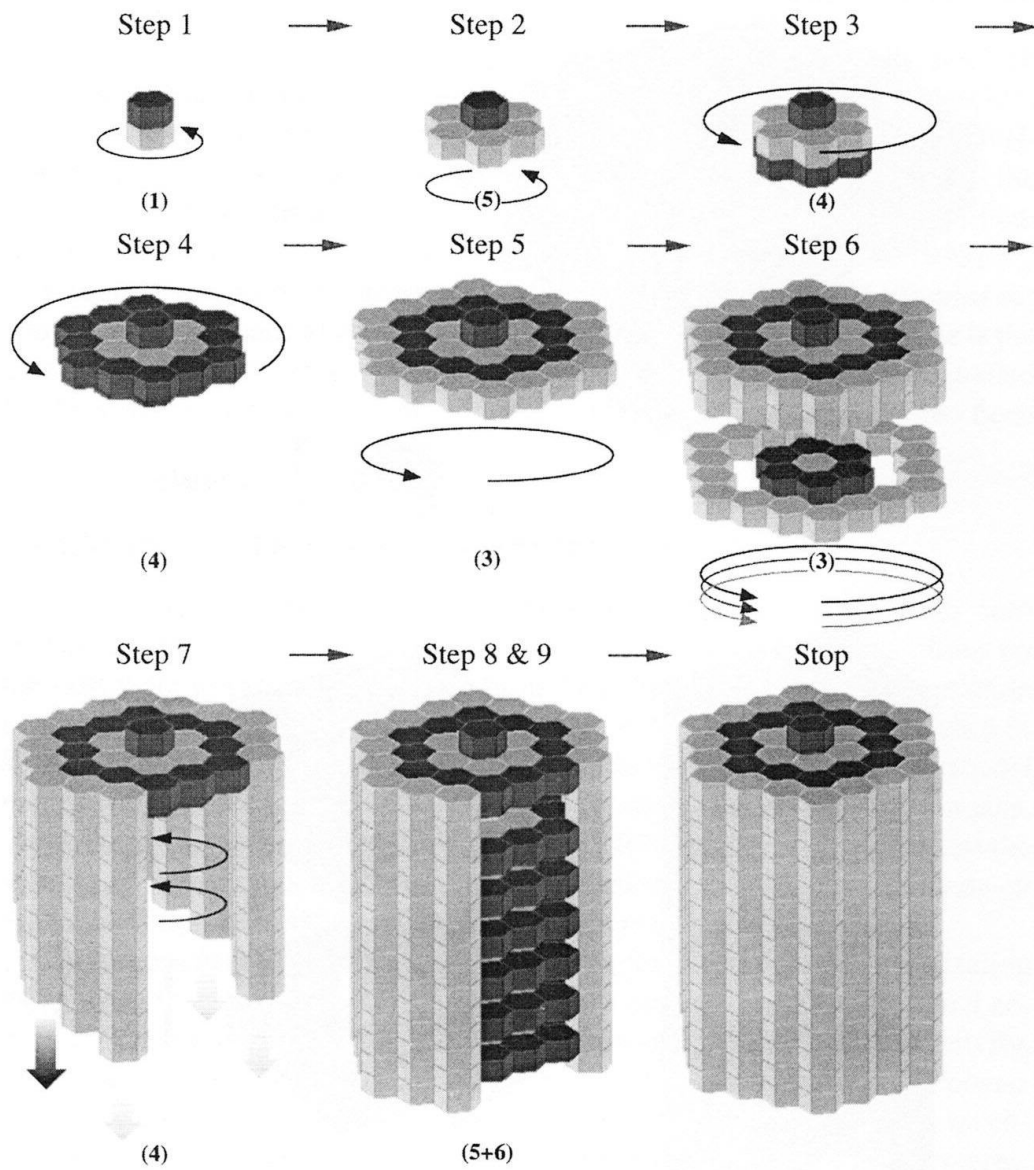

Example

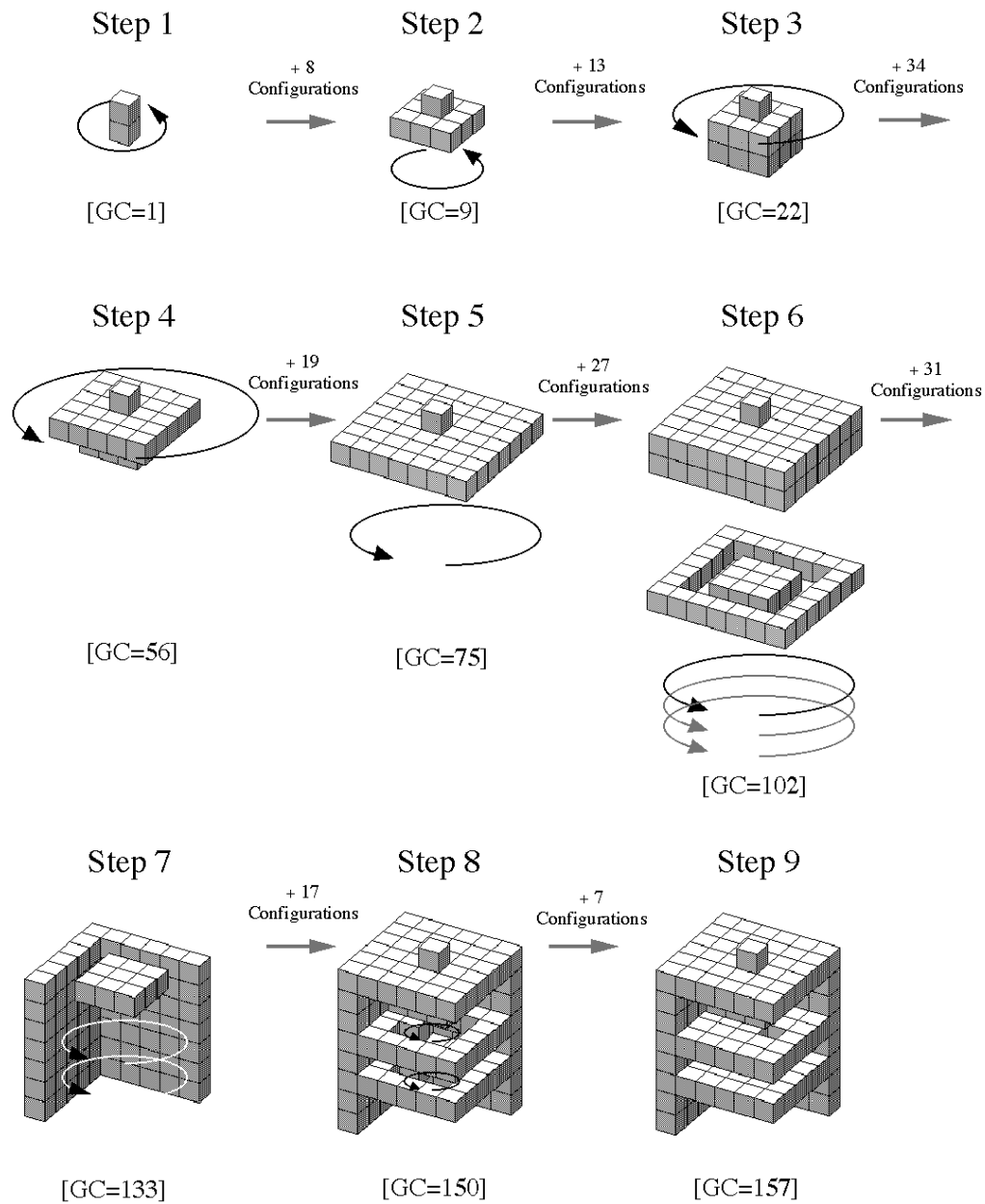

Example

Modular Structure

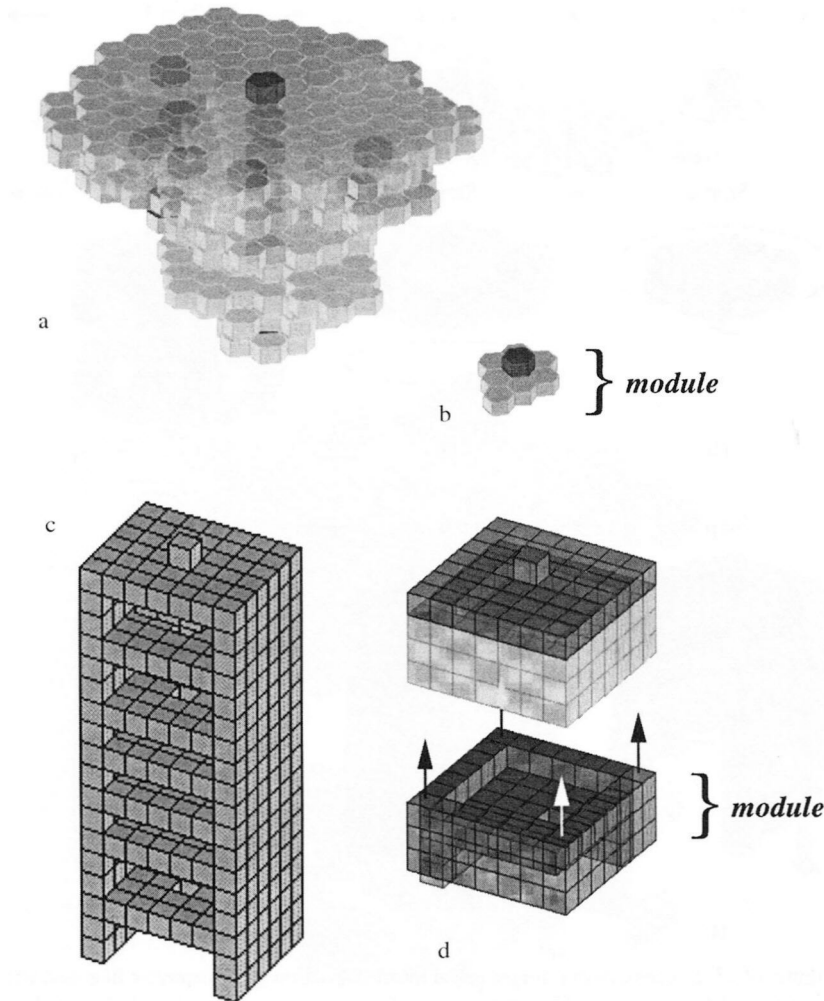

- Recurrent states induce cycles in group behavior
- These cycles induce modular structure
- Each module is built during a cycle
- Modules are qualitatively similar

Possible Termination Mechanisms

- Qualitative
 - the assembly process leads to a configuration that is not stimulating
- Quantitative
 - a separate rule inhibiting building when nest a certain size relative to population
 - “empty cells rule”: make new cells only when no empties available
 - growing nest may inhibit positive feedback mechanisms

Observations

- Random algorithms tend to lead to uninteresting structures
 - random or space-filling shapes
- Similar structured architectures tend to be generated by similar coordinated algorithms
- Algorithms that generate structured architectures seem to be confined to a small region of rule-space

Analysis

- Define matrix M:
 - 12 columns for 12 sample structured architectures
 - 211 rows for stimulating configurations
 - $M_{ij} = 1$ if architecture j requires configuration i

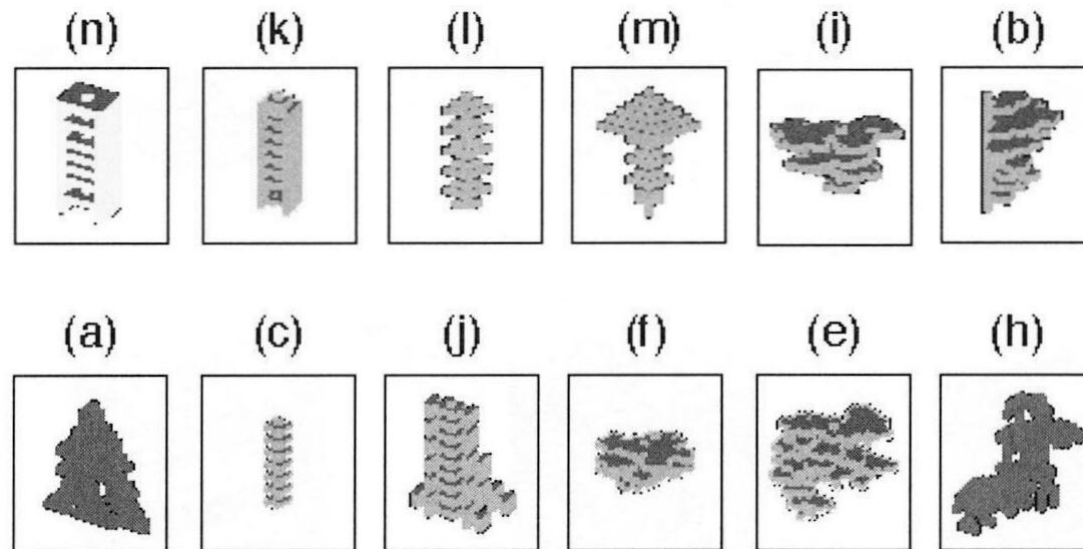

Factorial Correspondence Analysis

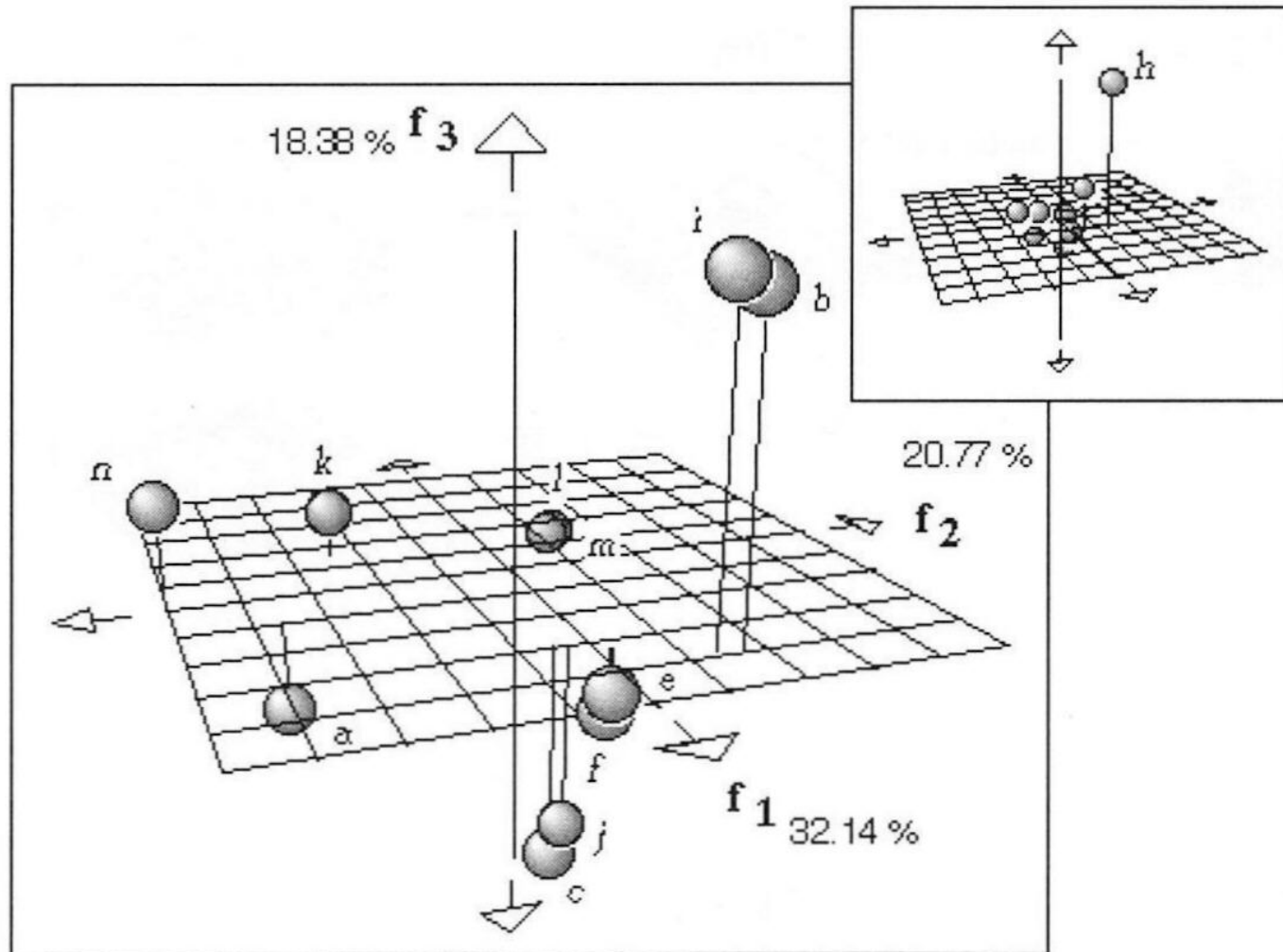

Conclusions

- Simple rules that exploit discrete (qualitative) stigmergy can be used by autonomous agents to assemble complex, 3D structures
- The rules must be non-conflicting and coordinated according to stage of assembly
- The rules corresponding to interesting structures occupy a comparatively small region in rule-space

The Termes Project

Wyss Institute for Biologically
Inspired Engineering
Harvard

Introduction



Self-Organizing Systems Research
School of Engineering and Applied Sciences
Harvard University

TERMES:
Simple Climbing Robots
Building 3D Structures



Algorithmic Assembly



Self-Organizing Systems Research
School of Engineering and Applied Sciences
Harvard University

Distributed Multi-Robot Algorithms for the TERMES 3D Collective Construction System

Justin Werfel, Kirstin Petersen, Radhika Nagpal

IROS 2011

Workshop on Reconfigurable Modular Robotics



The Robot

Self-Organizing Systems Research Group



Harvard University
School of Engineering and Applied Sciences
Wyss Institute for Biologically Inspired Engineering

Additional Bibliography

1. Camazine, S., Deneubourg, J.-L., Franks, N. R., Sneyd, J., Theraulaz, G., & Bonabeau, E. *Self-Organization in Biological Systems*. Princeton, 2001, chs. 11, 13, 18, 19.
2. Bonabeau, E., Dorigo, M., & Theraulaz, G. *Swarm Intelligence: From Natural to Artificial Systems*. Oxford, 1999, chs. 2, 6.
3. Solé, R., & Goodwin, B. *Signs of Life: How Complexity Pervades Biology*. Basic Books, 2000, ch. 6.
4. Resnick, M. *Turtles, Termites, and Traffic Jams: Explorations in Massively Parallel Microworlds*. MIT Press, 1994, pp. 59-68, 75-81.
5. Kennedy, J., & Eberhart, R. "Particle Swarm Optimization," *Proc. IEEE Int'l. Conf. Neural Networks* (Perth, Australia), 1995.
<http://www.engr.iupui.edu/~shi/ps.html>.