

IV. Neural Networks and Learning

3/3/17 1

A.
Artificial Neural Net Learning

3/3/17 2

Supervised Learning

- Produce desired outputs for training inputs
- Generalize reasonably & appropriately to other inputs
- Good example: pattern recognition
- Feedforward multilayer networks

3/3/17 3

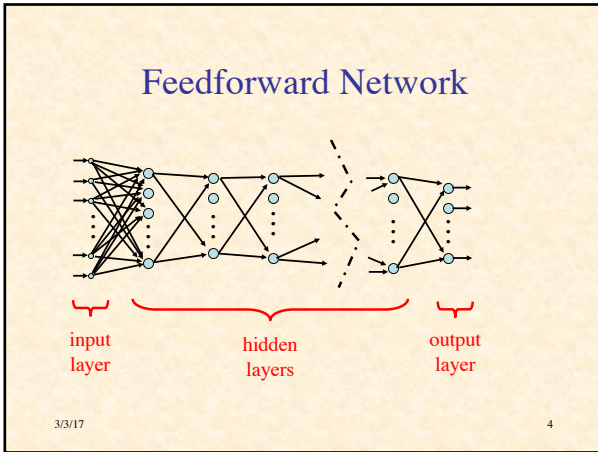

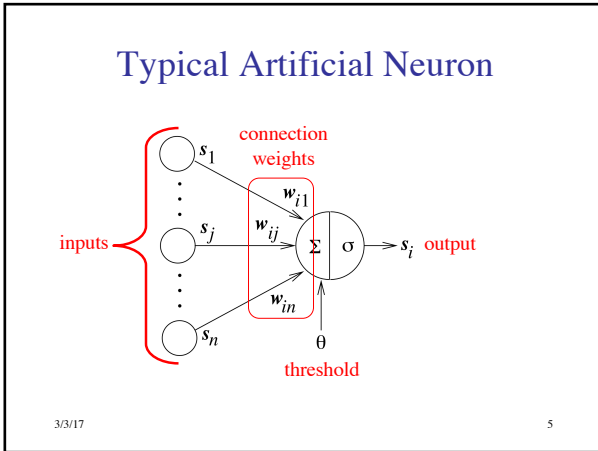

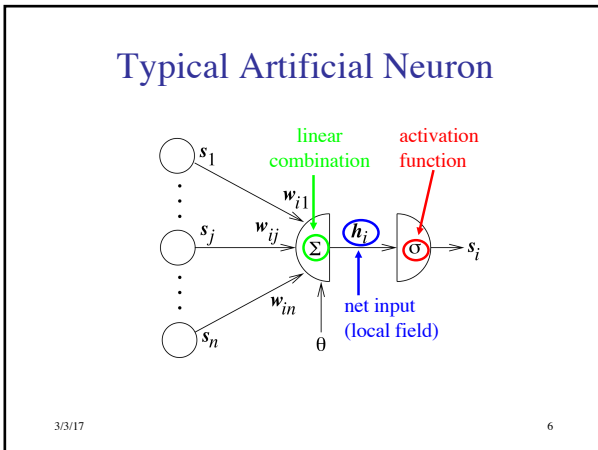

Equations

Net input:
$$h_i = \left(\sum_{j=1}^n w_{ij} s_j \right) - \theta$$
$$\mathbf{h} = \mathbf{W}\mathbf{s} - \theta$$

Neuron output:
$$s'_i = \sigma(h_i)$$
$$\mathbf{s}' = \sigma(\mathbf{h})$$

3/3/17 7

Single-Layer Perceptron

3/3/17 8

Variables

3/3/17 9

Single Layer Perceptron Equations

Binary threshold activation function :

$$\sigma(h) = \Theta(h) = \begin{cases} 1, & \text{if } h > 0 \\ 0, & \text{if } h \leq 0 \end{cases}$$

Hence, $y = \begin{cases} 1, & \text{if } \sum_j w_j x_j > \theta \\ 0, & \text{otherwise} \end{cases}$

$$= \begin{cases} 1, & \text{if } \mathbf{w} \cdot \mathbf{x} > \theta \\ 0, & \text{if } \mathbf{w} \cdot \mathbf{x} \leq \theta \end{cases}$$

3/3/17 10

2D Weight Vector

$\mathbf{w} \cdot \mathbf{x} = \|\mathbf{w}\| \|\mathbf{x}\| \cos \phi$

$\cos \phi = \frac{v}{\|\mathbf{x}\|}$

$\mathbf{w} \cdot \mathbf{x} = \|\mathbf{w}\| v$

$\mathbf{w} \cdot \mathbf{x} > \theta$
 $\Leftrightarrow \|\mathbf{w}\| v > \theta$
 $\Leftrightarrow v > \theta / \|\mathbf{w}\|$

3/3/17 11

N-Dimensional Weight Vector

separating hyperplane

normal vector

3/3/17 12

Goal of Perceptron Learning

- Suppose we have training patterns $\mathbf{x}^1, \mathbf{x}^2, \dots, \mathbf{x}^P$ with corresponding desired outputs y^1, y^2, \dots, y^P
- where $\mathbf{x}^p \in \{0, 1\}^n, y^p \in \{0, 1\}$
- We want to find \mathbf{w}, θ such that $y^p = \Theta(\mathbf{w} \cdot \mathbf{x}^p - \theta)$ for $p = 1, \dots, P$

3/3/17

13

Treating Threshold as Weight

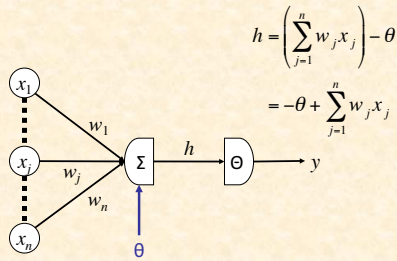

$$h = \left(\sum_{j=1}^n w_j x_j \right) - \theta$$

$$= -\theta + \sum_{j=1}^n w_j x_j$$

3/3/17

14

Treating Threshold as Weight

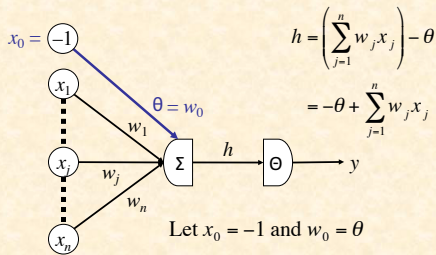

$$h = \left(\sum_{j=1}^n w_j x_j \right) - \theta$$

$$= -\theta + \sum_{j=1}^n w_j x_j$$

Let $x_0 = -1$ and $w_0 = \theta$

$$h = w_0 x_0 + \sum_{j=1}^n w_j x_j = \sum_{j=0}^n w_j x_j = \tilde{\mathbf{w}} \cdot \tilde{\mathbf{x}}$$

3/3/17

15

Augmented Vectors

$$\tilde{\mathbf{w}} = \begin{pmatrix} \theta \\ w_1 \\ \vdots \\ w_n \end{pmatrix} \quad \tilde{\mathbf{x}}^p = \begin{pmatrix} -1 \\ x_1^p \\ \vdots \\ x_n^p \end{pmatrix}$$

We want $y^p = \Theta(\tilde{\mathbf{w}} \cdot \tilde{\mathbf{x}}^p)$, $p = 1, \dots, P$

3/3/17 16

Reformulation as Positive Examples

We have positive ($y^p = 1$) and negative ($y^p = 0$) examples

Want $\tilde{\mathbf{w}} \cdot \tilde{\mathbf{x}}^p > 0$ for positive, $\tilde{\mathbf{w}} \cdot \tilde{\mathbf{x}}^p \leq 0$ for negative

Let $\mathbf{z}^p = \tilde{\mathbf{x}}^p$ for positive, $\mathbf{z}^p = -\tilde{\mathbf{x}}^p$ for negative

Want $\tilde{\mathbf{w}} \cdot \mathbf{z}^p \geq 0$, for $p = 1, \dots, P$

Hyperplane through origin with all \mathbf{z}^p on one side

3/3/17 17

Adjustment of Weight Vector

3/3/17 18

Outline of Perceptron Learning Algorithm

1. initialize weight vector randomly
2. until all patterns classified correctly, do:
 - a) for $p = 1, \dots, P$ do:
 - 1) if \mathbf{z}^p classified correctly, do nothing
 - 2) else adjust weight vector to be closer to correct classification

3/3/17 19

Weight Adjustment

3/3/17 20

Improvement in Performance

$$\begin{aligned}
 \tilde{\mathbf{w}}' \cdot \mathbf{z}^p &= (\tilde{\mathbf{w}} + \eta \mathbf{z}^p) \cdot \mathbf{z}^p \\
 &= \tilde{\mathbf{w}} \cdot \mathbf{z}^p + \eta \mathbf{z}^p \cdot \mathbf{z}^p \\
 &= \tilde{\mathbf{w}} \cdot \mathbf{z}^p + \eta \|\mathbf{z}^p\|^2 \\
 &> \tilde{\mathbf{w}} \cdot \mathbf{z}^p
 \end{aligned}$$

3/3/17 21

Perceptron Learning Theorem

- If there is a set of weights that will solve the problem,
- then the PLA will eventually find it
- (for a sufficiently small learning rate)
- Note: only applies if positive & negative examples are linearly separable

3/3/17 22

NetLogo Simulation of Perceptron Learning

[Run Perceptron-Geometry.nlogo](#)

3/3/17 23

Classification Power of Multilayer Perceptrons

- Perceptrons can function as logic gates
- Therefore MLP can form intersections, unions, differences of linearly-separable regions
- Classes can be arbitrary *hyperpolyhedra*
- Minsky & Papert criticism of perceptrons
- No one succeeded in developing a MLP learning algorithm

3/3/17 24

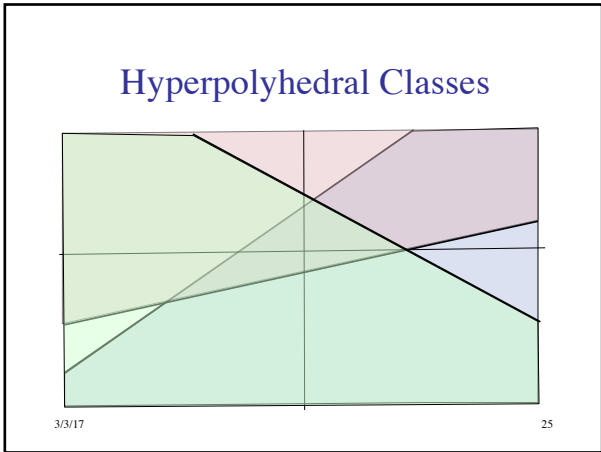

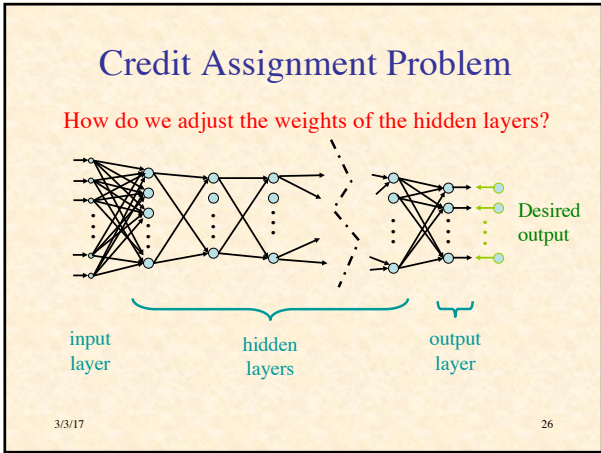

NetLogo Demonstration of Back-Propagation Learning

[Run Artificial Neural Net.nlogo](#)

3/3/17 27

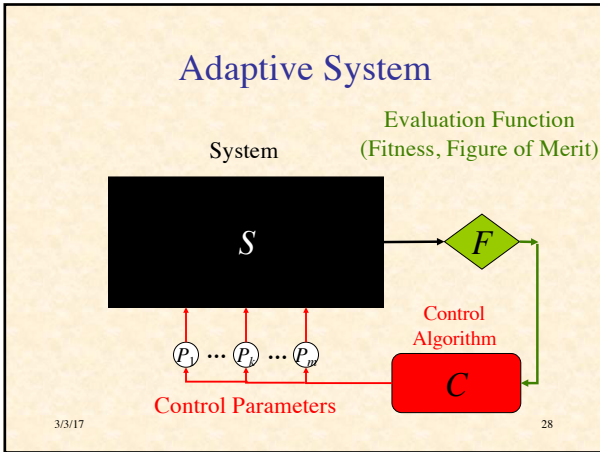

Gradient

$\frac{\partial F}{\partial P_k}$ measures how F is altered by variation of P_k

$$\nabla F = \begin{pmatrix} \frac{\partial F}{\partial P_1} \\ \vdots \\ \frac{\partial F}{\partial P_k} \\ \vdots \\ \frac{\partial F}{\partial P_m} \end{pmatrix}$$

∇F points in direction of maximum local increase in F

3/3/17 29

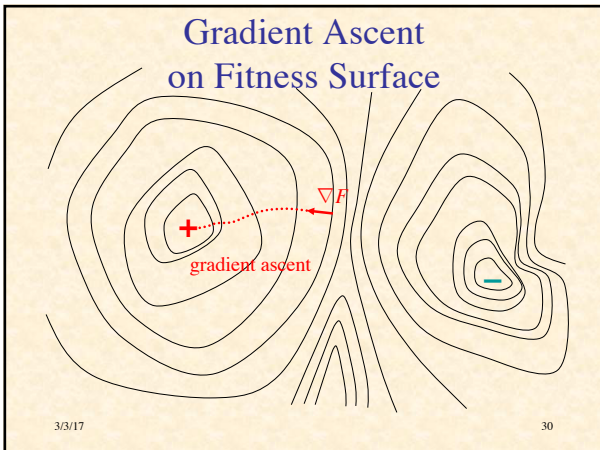

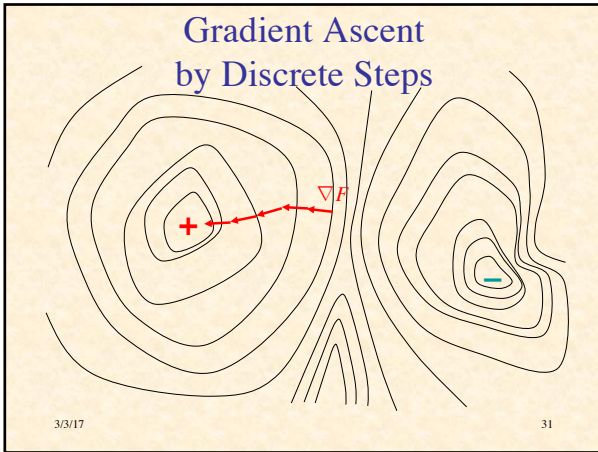

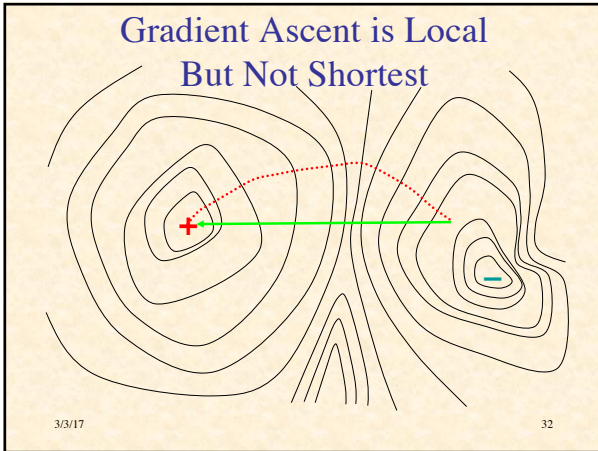

Gradient Ascent Process

$$\dot{\mathbf{P}} = \eta \nabla F(\mathbf{P})$$

Change in fitness :

$$\dot{F} = \frac{dF}{dt} = \sum_{k=1}^m \frac{\partial F}{\partial P_k} \frac{dP_k}{dt} = \sum_{k=1}^m (\nabla F)_k \dot{P}_k$$

$$\dot{F} = \nabla F \cdot \dot{\mathbf{P}}$$

$$\dot{F} = \nabla F \cdot \eta \nabla F = \eta \|\nabla F\|^2 \geq 0$$

Therefore gradient ascent increases fitness
(until reaches 0 gradient)

3/3/17 33

General Ascent in Fitness

Note that any adaptive process $\mathbf{P}(t)$ will increase fitness provided:

$$0 < \dot{F} = \nabla F \cdot \dot{\mathbf{P}} = \|\nabla F\| \|\dot{\mathbf{P}}\| \cos \varphi$$

where φ is angle between ∇F and $\dot{\mathbf{P}}$

Hence we need $\cos \varphi > 0$
or $|\varphi| < 90^\circ$

3/3/17 34

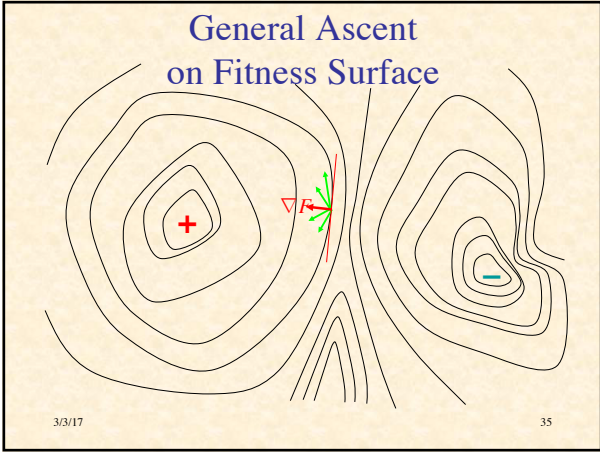

Fitness as Minimum Error

Suppose for Q different inputs we have target outputs t^1, \dots, t^Q

Suppose for parameters \mathbf{P} the corresponding actual outputs are y^1, \dots, y^Q

Suppose $D(t, y) \in [0, \infty)$ measures difference between target & actual outputs

Let $E^q = D(t^q, y^q)$ be error on q th sample

$$\text{Let } F(\mathbf{P}) = -\sum_{q=1}^Q E^q(\mathbf{P}) = -\sum_{q=1}^Q D[t^q, y^q(\mathbf{P})]$$

3/3/17 36

Gradient of Fitness

$$\nabla F = \nabla \left(-\sum_q E^q \right) = -\sum_q \nabla E^q$$

$$\frac{\partial E^q}{\partial P_k} = \frac{\partial}{\partial P_k} D(\mathbf{t}^q, \mathbf{y}^q) = \sum_j \frac{\partial D(\mathbf{t}^q, \mathbf{y}^q)}{\partial y_j^q} \frac{\partial y_j^q}{\partial P_k}$$

$$= \frac{dD(\mathbf{t}^q, \mathbf{y}^q)}{d\mathbf{y}^q} \cdot \frac{\partial \mathbf{y}^q}{\partial P_k}$$

$$= \nabla_{\mathbf{y}^q} D(\mathbf{t}^q, \mathbf{y}^q) \cdot \frac{\partial \mathbf{y}^q}{\partial P_k}$$

3/3/17 37

Jacobian Matrix

Define Jacobian matrix $\mathbf{J}^q = \begin{pmatrix} \partial y_1^q / \partial P_1 & \dots & \partial y_1^q / \partial P_m \\ \vdots & \ddots & \vdots \\ \partial y_n^q / \partial P_1 & \dots & \partial y_n^q / \partial P_m \end{pmatrix}$

Note $\mathbf{J}^q \in \mathbb{R}^{n \times m}$ and $\nabla D(\mathbf{t}^q, \mathbf{y}^q) \in \mathbb{R}^{n \times 1}$

Since $(\nabla E^q)_k = \frac{\partial E^q}{\partial P_k} = \sum_j \frac{\partial y_j^q}{\partial P_k} \frac{\partial D(\mathbf{t}^q, \mathbf{y}^q)}{\partial y_j^q}$,

$\therefore \nabla E^q = (\mathbf{J}^q)^T \nabla D(\mathbf{t}^q, \mathbf{y}^q)$

3/3/17 38

Derivative of Squared Euclidean Distance

Suppose $D(\mathbf{t}, \mathbf{y}) = \|\mathbf{t} - \mathbf{y}\|^2 = \sum_i (t_i - y_i)^2$

$$\frac{\partial D(\mathbf{t} - \mathbf{y})}{\partial y_j} = \frac{\partial}{\partial y_j} \sum_i (t_i - y_i)^2 = \sum_i \frac{\partial (t_i - y_i)^2}{\partial y_j}$$

$$= \frac{d(t_j - y_j)^2}{d y_j} = -2(t_j - y_j)$$

$\therefore \frac{dD(\mathbf{t}, \mathbf{y})}{d\mathbf{y}} = 2(\mathbf{y} - \mathbf{t})$

3/3/17 39

Gradient of Error on q^{th} Input

$$\begin{aligned} \frac{\partial E^q}{\partial P_k} &= \frac{dD(\mathbf{t}^q, \mathbf{y}^q)}{d\mathbf{y}^q} \cdot \frac{\partial \mathbf{y}^q}{\partial P_k} \\ &= 2(\mathbf{y}^q - \mathbf{t}^q) \cdot \frac{\partial \mathbf{y}^q}{\partial P_k} \\ &= 2 \sum_j (y_j^q - t_j^q) \frac{\partial y_j^q}{\partial P_k} \\ \nabla E^q &= 2(\mathbf{J}^q)^T (\mathbf{y}^q - \mathbf{t}^q) \end{aligned}$$

3/3/17 40

Recap

$$\dot{\mathbf{P}} = \eta \sum_q (\mathbf{J}^q)^T (\mathbf{t}^q - \mathbf{y}^q)$$

To know how to decrease the differences between actual & desired outputs,

we need to know elements of Jacobian, $\frac{\partial y_j^q}{\partial P_k}$,

which says how j th output varies with k th parameter (given the q th input)

The Jacobian depends on the specific form of the system, in this case, a feedforward neural network

3/3/17 41

Multilayer Notation

3/3/17 42

Notation

- L layers of neurons labeled $1, \dots, L$
- N_l neurons in layer l
- $\mathbf{s}^l =$ vector of outputs from neurons in layer l
- input layer $\mathbf{s}^1 = \mathbf{x}^q$ (the input pattern)
- output layer $\mathbf{s}^L = \mathbf{y}^q$ (the actual output)
- $\mathbf{W}^l =$ weights between layers l and $l+1$
- Problem: find out how outputs y_i^q vary with weights W_{jk}^l ($l = 1, \dots, L-1$)

3/3/17

43

Typical Neuron

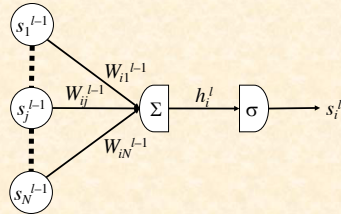

3/3/17

44

Error Back-Propagation

We will compute $\frac{\partial E^q}{\partial W_{ij}^l}$ starting with last layer ($l = L - 1$)
and working back to earlier layers ($l = L - 2, \dots, 1$)

3/3/17

45

Delta Values

Convenient to break derivatives by chain rule :

$$\frac{\partial E^q}{\partial W_{ij}^{l-1}} = \frac{\partial E^q}{\partial h_i^l} \frac{\partial h_i^l}{\partial W_{ij}^{l-1}}$$

Let $\delta_i^l = \frac{\partial E^q}{\partial h_i^l}$

So $\frac{\partial E^q}{\partial W_{ij}^{l-1}} = \delta_i^l \frac{\partial h_i^l}{\partial W_{ij}^{l-1}}$

3/3/17

46

Output-Layer Neuron

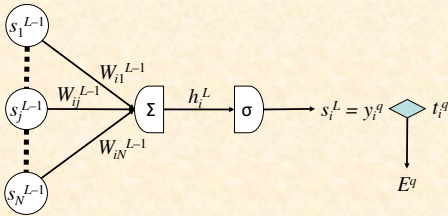

3/3/17

47

Output-Layer Derivatives (1)

$$\begin{aligned} \delta_i^L &= \frac{\partial E^q}{\partial h_i^L} = \frac{\partial}{\partial h_i^L} \sum_k (s_k^L - t_k^q)^2 \\ &= \frac{d(s_i^L - t_i^q)^2}{d h_i^L} = 2(s_i^L - t_i^q) \frac{d s_i^L}{d h_i^L} \\ &= 2(s_i^L - t_i^q) \sigma'(h_i^L) \end{aligned}$$

3/3/17

48

Output-Layer Derivatives (2)

$$\frac{\partial h_i^L}{\partial W_{ij}^{L-1}} = \frac{\partial}{\partial W_{ij}^{L-1}} \sum_k W_{ik}^{L-1} s_k^{L-1} = s_j^{L-1}$$

$$\therefore \frac{\partial E^q}{\partial W_{ij}^{L-1}} = \delta_i^L \delta_j^{L-1}$$

$$\text{where } \delta_i^L = 2(s_i^L - t_i^q) \sigma'(h_i^L)$$

3/3/17

49

Hidden-Layer Neuron

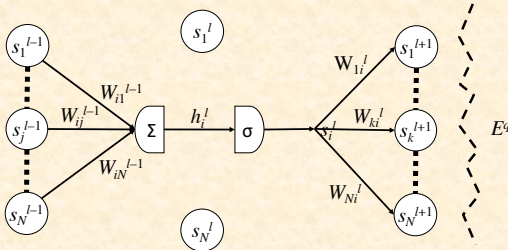

3/3/17

50

Hidden-Layer Derivatives (1)

Recall $\frac{\partial E^q}{\partial W_{ij}^{l-1}} = \delta_i^l \frac{\partial h_i^l}{\partial W_{ij}^{l-1}}$

$$\delta_i^l = \frac{\partial E^q}{\partial h_i^l} = \sum_k \frac{\partial E^q}{\partial h_k^{l+1}} \frac{\partial h_k^{l+1}}{\partial h_i^l} = \sum_k \delta_k^{l+1} \frac{\partial h_k^{l+1}}{\partial h_i^l}$$

$$\frac{\partial h_k^{l+1}}{\partial h_i^l} = \frac{\partial \sum_m W_{km}^l s_m^l}{\partial h_i^l} = \frac{\partial W_{ki}^l s_i^l}{\partial h_i^l} = W_{ki}^l \frac{d\sigma(h_i^l)}{dh_i^l} = W_{ki}^l \sigma'(h_i^l)$$

$$\therefore \delta_i^l = \sum_k \delta_k^{l+1} W_{ki}^l \sigma'(h_i^l) = \sigma'(h_i^l) \sum_k \delta_k^{l+1} W_{ki}^l$$

3/3/17

51

Hidden-Layer Derivatives (2)

$$\frac{\partial h_i^l}{\partial W_{ij}^{l-1}} = \frac{\partial}{\partial W_{ij}^{l-1}} \sum_k W_{ik}^{l-1} s_k^{l-1} = \frac{dW_{ij}^{l-1} s_j^{l-1}}{dW_{ij}^{l-1}} = s_j^{l-1}$$

$$\therefore \frac{\partial E^q}{\partial W_{ij}^{l-1}} = \delta_i^l s_j^{l-1}$$

where $\delta_i^l = \sigma'(h_i^l) \sum_k \delta_k^{l+1} W_{ki}^l$

3/3/17 52

Derivative of Sigmoid

Suppose $s = \sigma(h) = \frac{1}{1 + \exp(-\alpha h)}$ (logistic sigmoid)

$$D_h s = D_h [1 + \exp(-\alpha h)]^{-1} = -[1 + \exp(-\alpha h)]^{-2} D_h (1 + e^{-\alpha h})$$

$$= -(1 + e^{-\alpha h})^{-2} (-\alpha e^{-\alpha h}) = \alpha \frac{e^{-\alpha h}}{(1 + e^{-\alpha h})^2}$$

$$= \alpha \frac{1}{1 + e^{-\alpha h}} \frac{e^{-\alpha h}}{1 + e^{-\alpha h}} = \alpha s \left(\frac{1 + e^{-\alpha h}}{1 + e^{-\alpha h}} - \frac{1}{1 + e^{-\alpha h}} \right)$$

$$= \alpha s(1 - s)$$

3/3/17 53

Summary of Back-Propagation Algorithm

Output layer : $\delta_i^l = 2\alpha s_i^l (1 - s_i^l) (s_i^l - t_i^q)$

$$\frac{\partial E^q}{\partial W_{ij}^{l-1}} = \delta_i^l s_j^{l-1}$$

Hidden layers : $\delta_i^l = \alpha s_i^l (1 - s_i^l) \sum_k \delta_k^{l+1} W_{ki}^l$

$$\frac{\partial E^q}{\partial W_{ij}^{l-1}} = \delta_i^l s_j^{l-1}$$

3/3/17 54

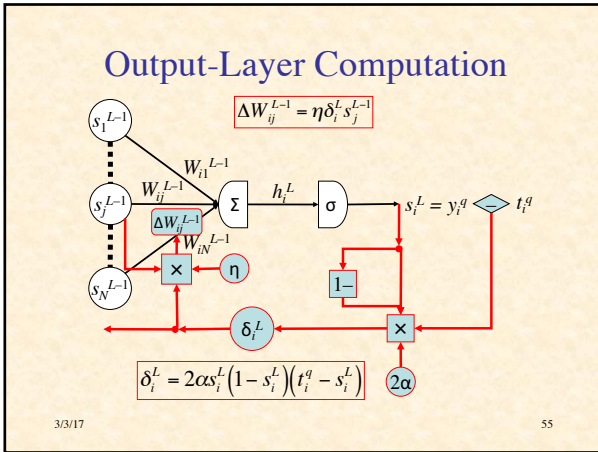

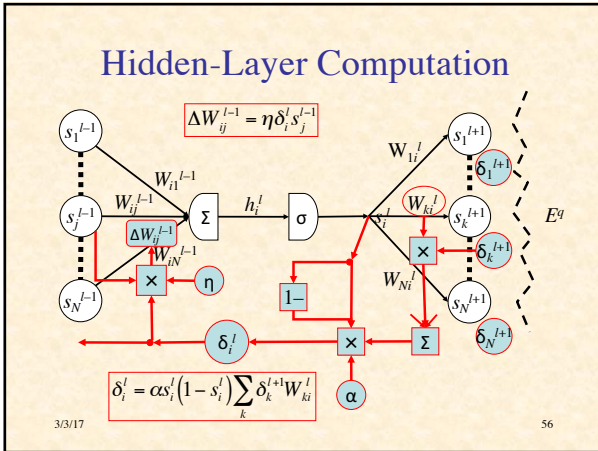

- ### Training Procedures
- Batch Learning
 - on each *epoch* (pass through all the training pairs),
 - weight changes for all patterns accumulated
 - weight matrices updated at end of epoch
 - accurate computation of gradient
 - Online Learning
 - weight are updated after back-prop of each training pair
 - usually randomize order for each epoch
 - approximation of gradient
 - Doesn't make much difference
- 3/3/17 57

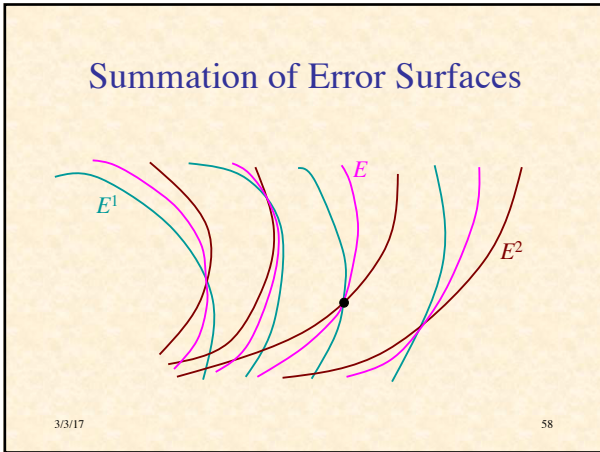

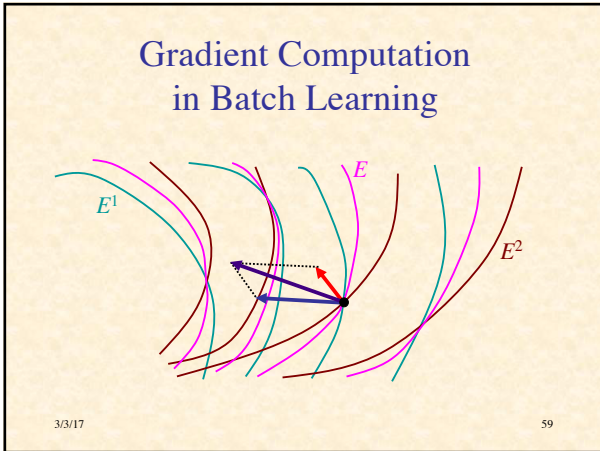

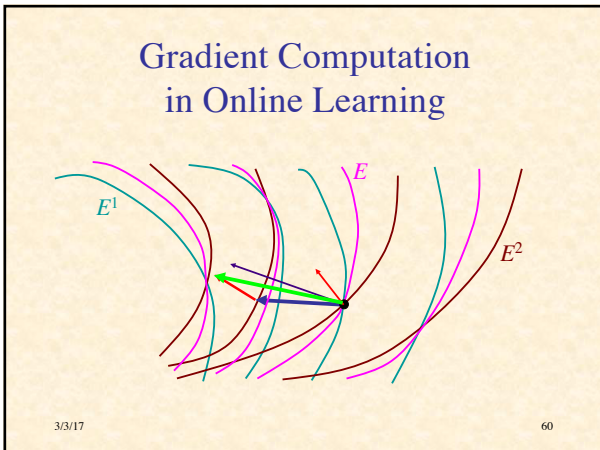

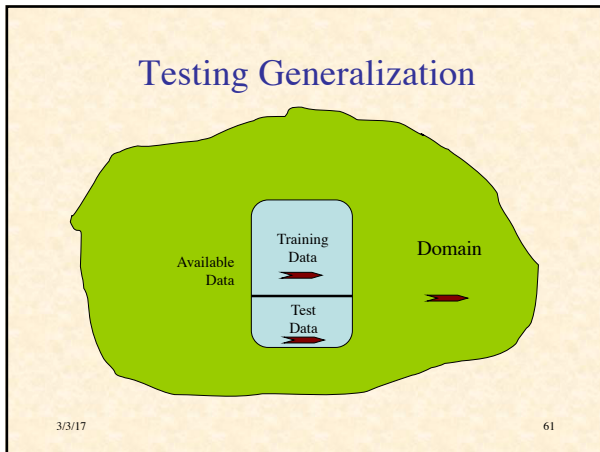

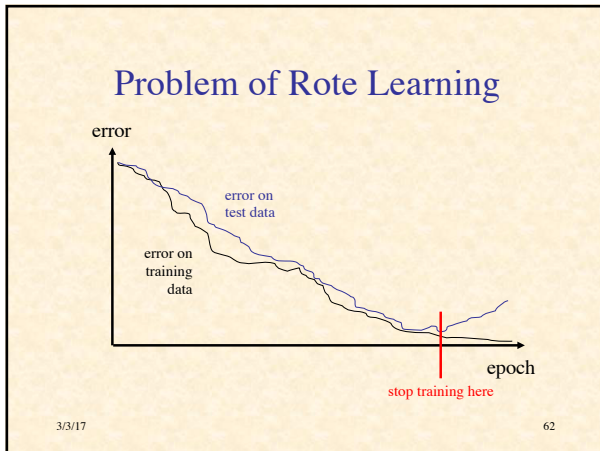

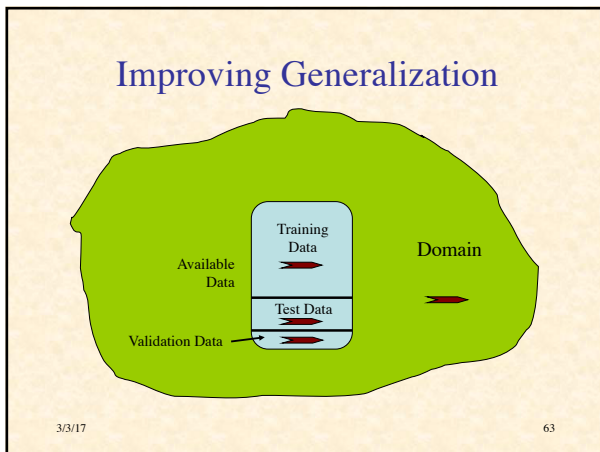

A Few Random Tips

- Too few neurons and the ANN may not be able to decrease the error enough
- Too many neurons can lead to rote learning
- Preprocess data to:
 - standardize
 - eliminate irrelevant information
 - capture invariances
 - keep relevant information
- If stuck in local min., restart with different random weights

3/3/17 64

Run Example BP Learning

3/3/17 65

Beyond Back-Propagation

- Adaptive Learning Rate
- Adaptive Architecture
 - Add/delete hidden neurons
 - Add/delete hidden layers
- Radial Basis Function Networks
- Recurrent BP
- Etc., etc., etc....

3/3/17 66

Deep Belief Networks

- Inspired by hierarchical representations in mammalian sensory systems
- Use “deep” (multilayer) feed-forward nets
- Layers self-organize to represent input at progressively more abstract, task-relevant levels
- Supervised training (e.g., BP) can be used to tune network performance.
- Each layer is a *Restricted Boltzmann Machine*

3/3/17

67

Restricted Boltzmann Machine

- Goal: hidden units become model of input domain
- Should capture statistics of input
- Evaluate by testing its ability to reproduce input statistics
- Change weights to decrease difference

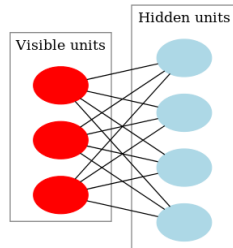

(fig. from wikipedia) 68

3/3/17

Unsupervised RBM Learning

- Stochastic binary units
- Assume bias units $x_0 = y_0 = 1$
- Set y_i with probability $\sigma\left(\sum_j W_{ij}x_j\right)$
- Set x_j with probability $\sigma\left(\sum_i W_{ij}y_i\right)$
- Set y_i with probability $\sigma\left(\sum_j W_{ij}x_j'\right)$
- After several cycles of sampling, update weights based on statistics: $\Delta W_{ij} = \eta(\langle y_i x_j \rangle - \langle y_i' x_j' \rangle)$

3/3/17

69

Training a DBN Network

- Present inputs and do RBM learning with first hidden layer to develop model
- When converged, do RBM learning between first and second hidden layers to develop higher-level model
- Continue until all weight layers trained
- May further train with BP or other supervised learning algorithms

3/3/17 70

What is the Power of Artificial Neural Networks?

- With respect to Turing machines?
- As function approximators?

3/3/17 71

Can ANNs Exceed the “Turing Limit”?

- There are many results, which depend sensitively on assumptions; for example:
- Finite NNs with real-valued weights have super-Turing power (Siegelmann & Sontag ‘94)
- Recurrent nets with Gaussian noise have sub-Turing power (Maass & Sontag ‘99)
- Finite recurrent nets with real weights can recognize all languages, and thus are super-Turing (Siegelmann ‘99)
- Stochastic nets with rational weights have super-Turing power (but only P/POLY, BPP/log^c) (Siegelmann ‘99)
- But computing classes of functions is not a very relevant way to evaluate the capabilities of neural computation

3/3/17 72

A Universal Approximation Theorem

Suppose f is a continuous function on $[0,1]^n$
 Suppose σ is a nonconstant, bounded,
 monotone increasing real function on \mathfrak{R} .

For any $\epsilon > 0$, there is an m such that

$\exists \mathbf{a} \in \mathfrak{R}^m, \mathbf{b} \in \mathfrak{R}^n, \mathbf{W} \in \mathfrak{R}^{m \times n}$ such that if

$$F(x_1, \dots, x_n) = \sum_{i=1}^m a_i \sigma \left(\sum_{j=1}^n W_{ij} x_j + b_j \right)$$

[i.e., $F(\mathbf{x}) = \mathbf{a} \cdot \sigma(\mathbf{W}\mathbf{x} + \mathbf{b})$]

then $|F(\mathbf{x}) - f(\mathbf{x})| < \epsilon$ for all $\mathbf{x} \in [0,1]^n$

3/3/17

(see, e.g., Haykin, *N.Nets 2/e*, 208-9)

73

One Hidden Layer is Sufficient

- **Conclusion:** One hidden layer is sufficient to approximate any continuous function arbitrarily closely

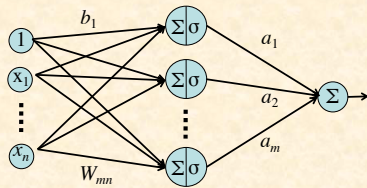

3/3/17

74

The Golden Rule of Neural Nets

Neural Networks are the
second-best way
 to do *everything*!

3/3/17



75
