

5. Brain Areas

“Geography of the Forehead”

Everyone thinks the brain is so complicated, but let's look at the facts. The frontal lobe, for example, is located in the front! And the temporal lobe is where the clock is. What could be simpler?

The hippocampal fissure is where big, dumb thoughts camp, while at the Fissure of Rolando dark-skinned men with one gold earring lie around the fire and play guitars.

The superior frontal convolution is where a lot of really nice houses are set back off a twisty road, while the inferior frontal convolution is a kind of trailer park, regularly leveled by brainstorm.

The area of Broca is pretty much off limits. And if you know Broca, you know why.

“Geography of the Forehead” by Ron Koertge from *Geography of the Forehead*. © The University of Arkansas Press, 2000.

Outline

- A. Functional Anatomy of the Brain
- B. Perception and Attention
- C. Motor Control
- D. Learning and Memory
- E. Language
- F. Executive Function

A. Functional Anatomy of the Brain

Comparing and Contrasting Major Brain Areas

► The Lobes of the Cerebral Hemispheres

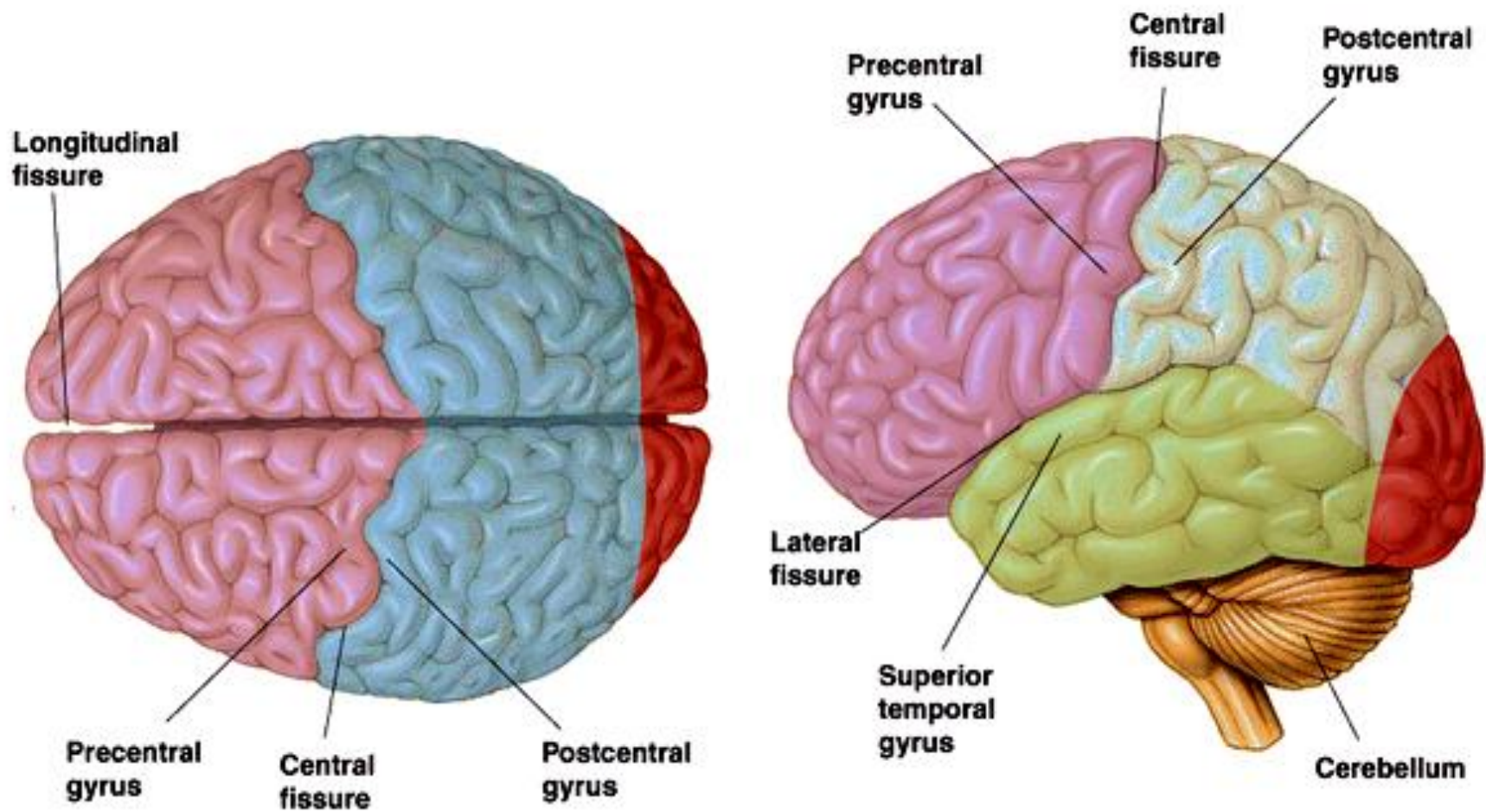

COSC 494/594 CCN
(fig. from internet)

Other (Subcortical) Areas

- Hippocampus: rapid learning
- Thalamus: sensory input, attention
- Amygdala: emotion, fear/desire
- Basal Ganglia: motor control, gating of PFC
- Cerebellum: coordinating movements
- Reward prediction system: dopamine release

Subcortical Areas

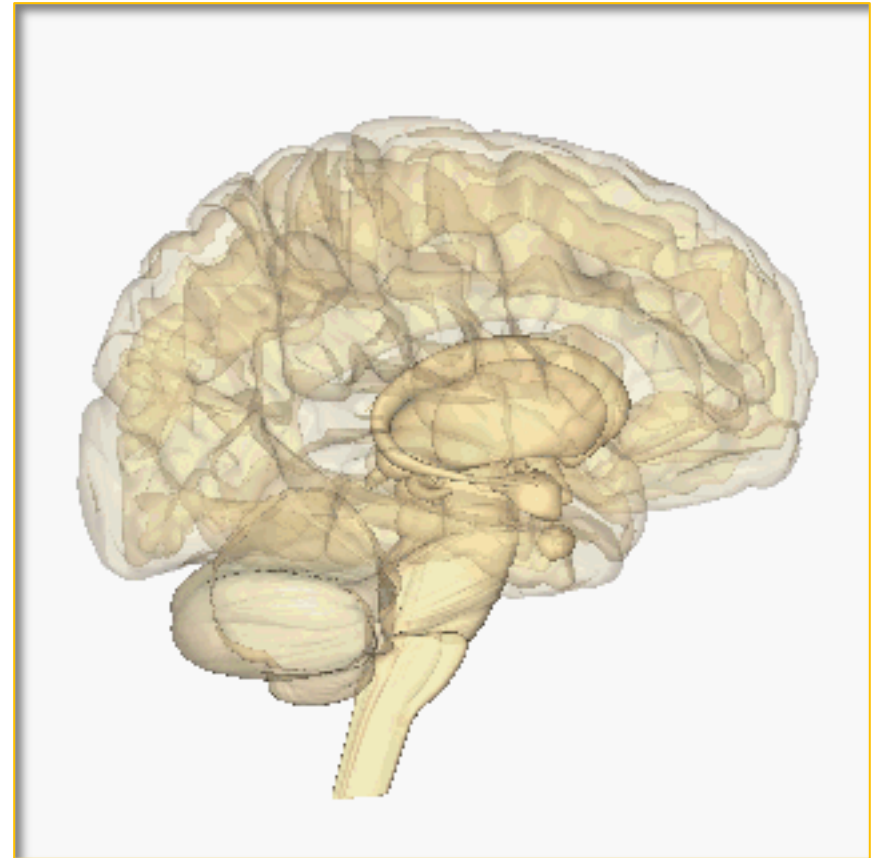
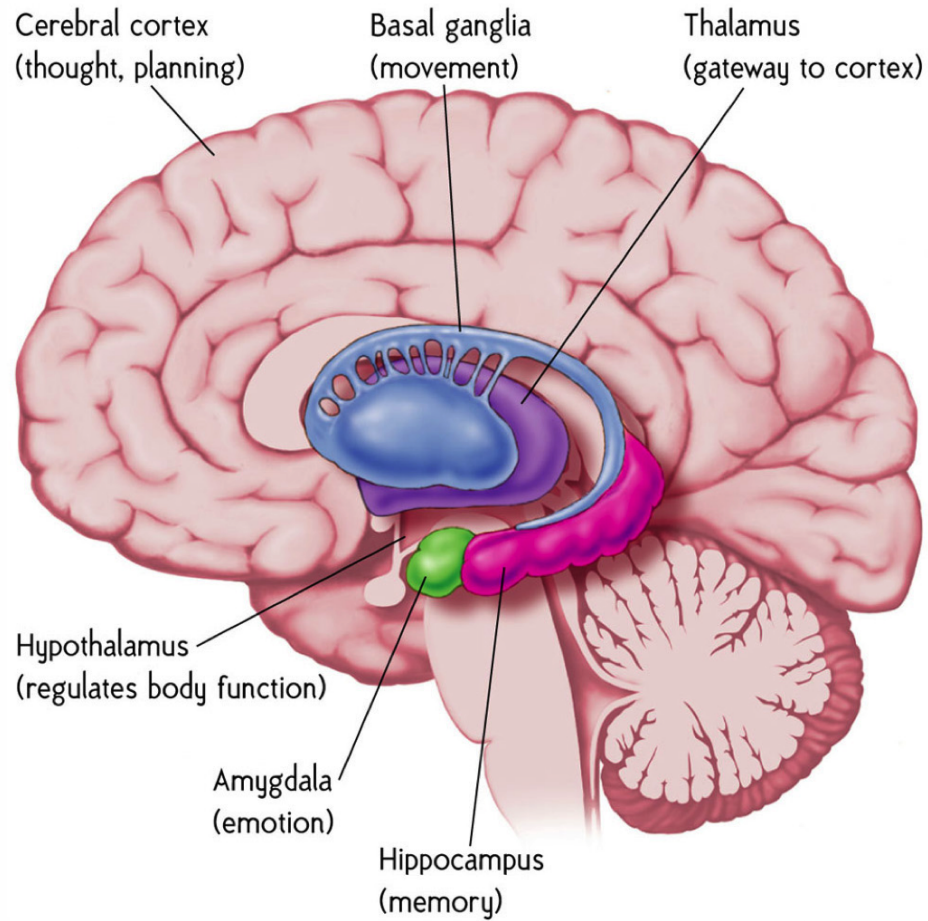

Interactive Images

- Atlas of Brain Injury and Anatomy
<http://www.finr.net/files/brain/index.htm>
- Brain Anatomy (Koshland Science Museum)
<http://www.koshland-science-museum.org/explore-the-science/interactives/brain-anatomy>

Left Hemisphere



Intercortical Connections

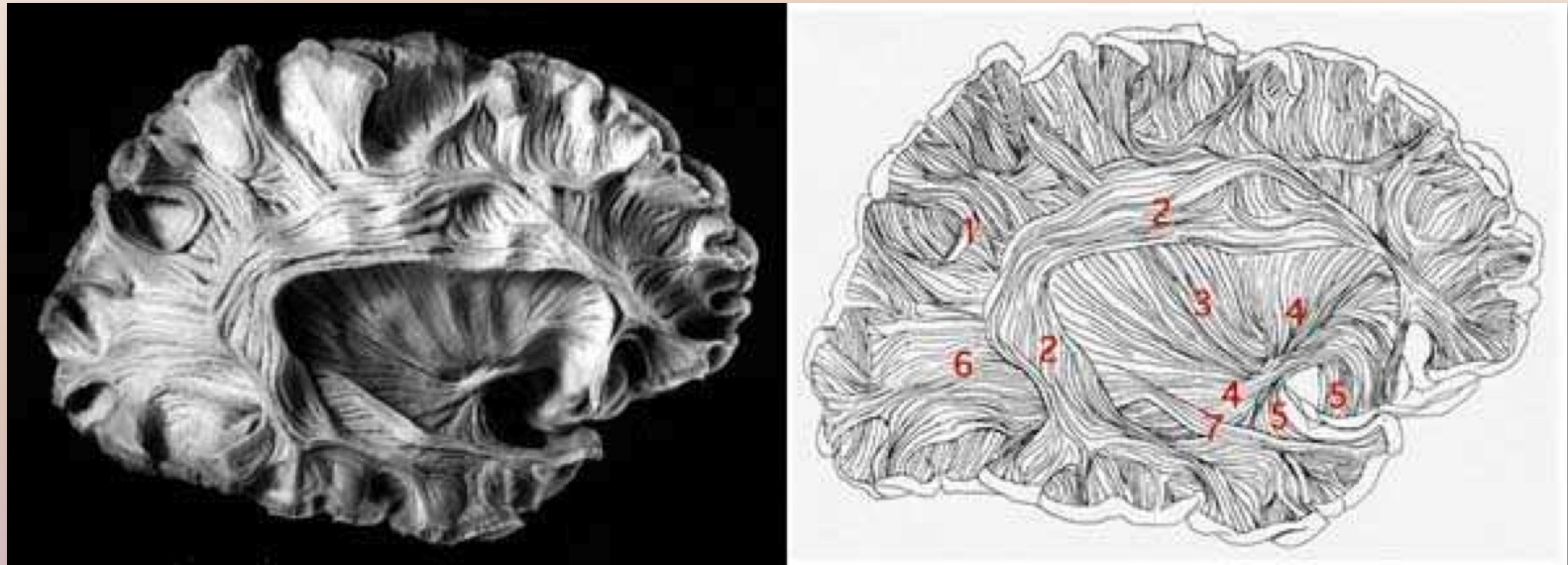

- (1) Short arcuate bundles, (2) Superior longitudinal fasciculus,
(3) External capsule, (4) Inferior occipitofrontal fasciculus,
(5) Uncinate fasciculus, (6) Sagittal stratum,
(7) Inferior longitudinal fasciculus

Intercortical Connections (diffusion spectrum imaging)

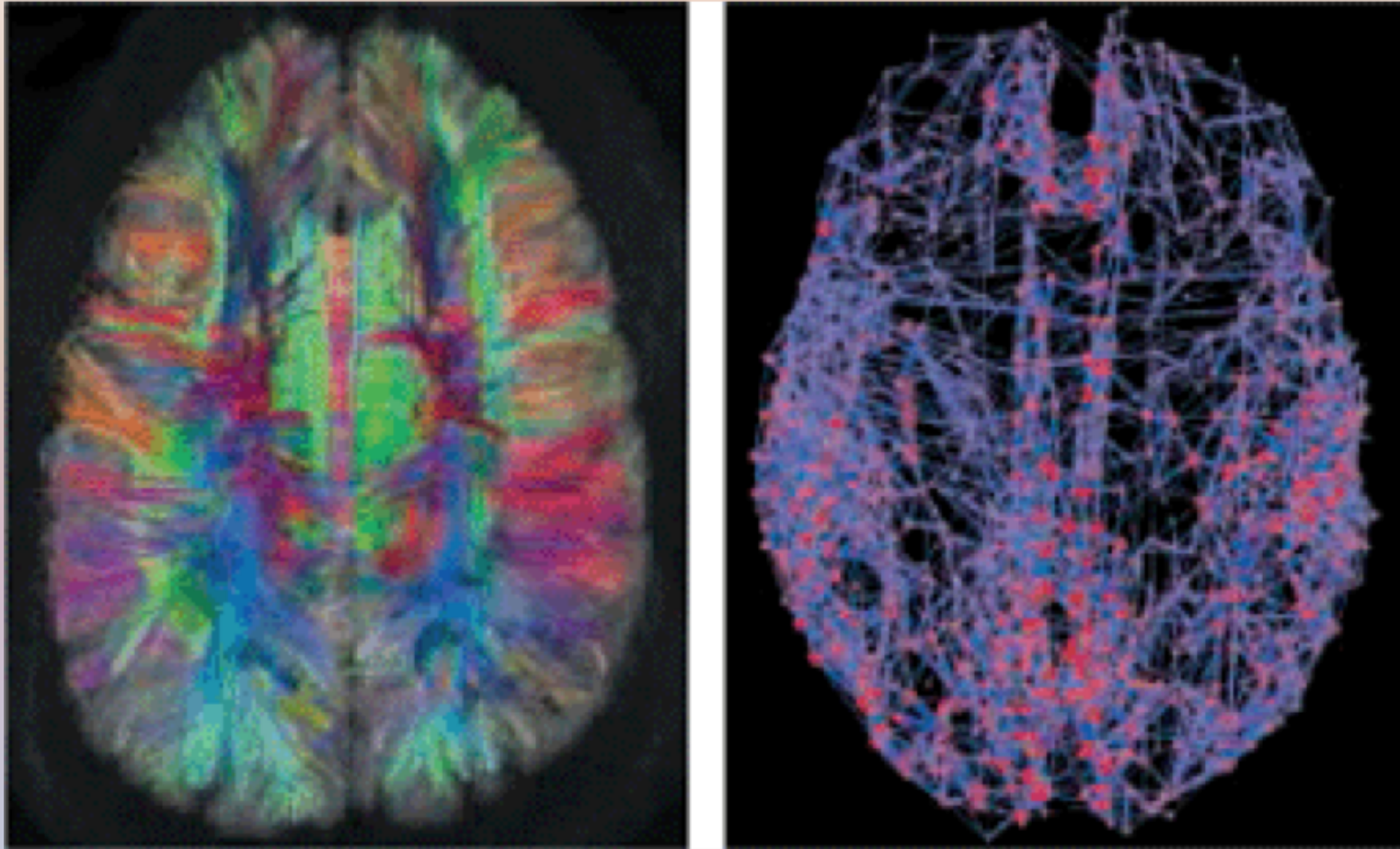

2/8/18

COSC 494/594 CCN

G. Miller Science 330, 164 (2010) (2010)

Published by AAAS

Brodmann's Areas

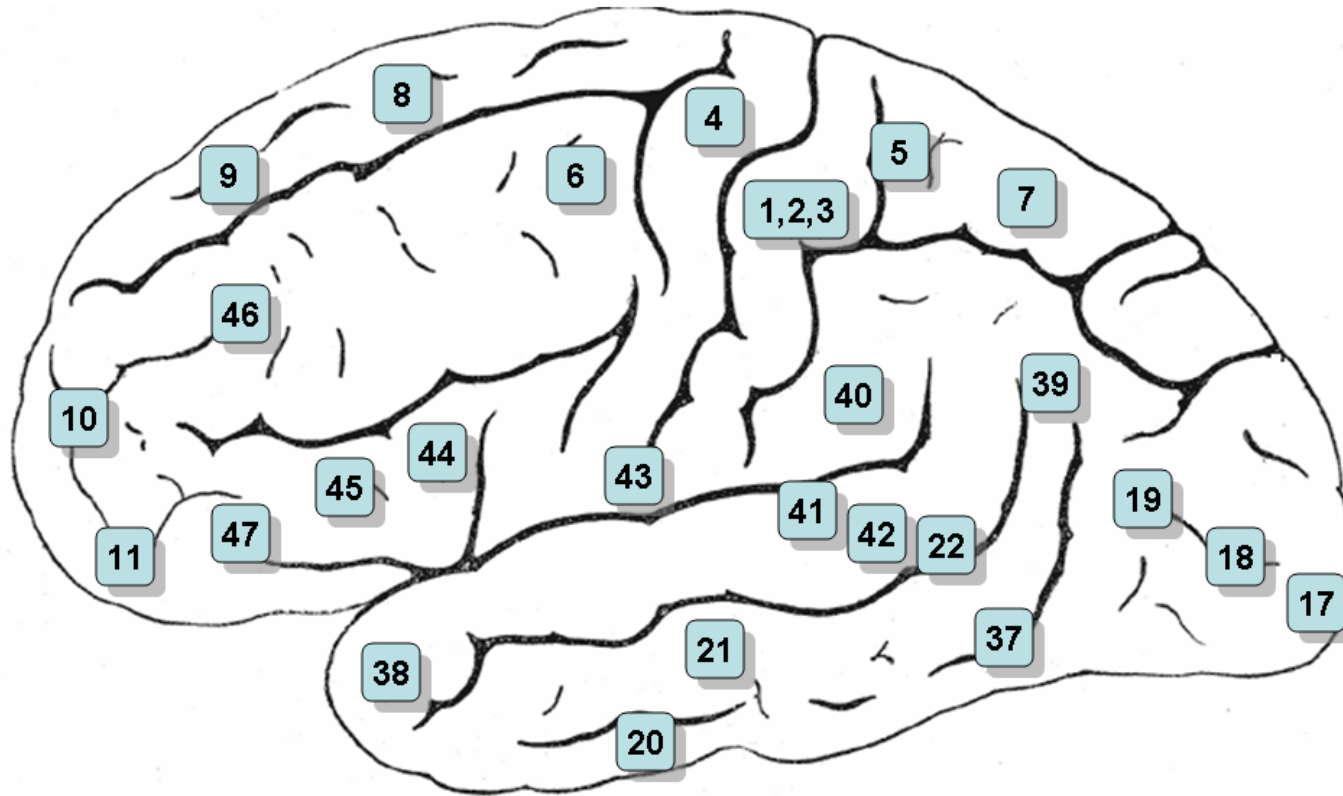

General Functions of Cortical Lobes

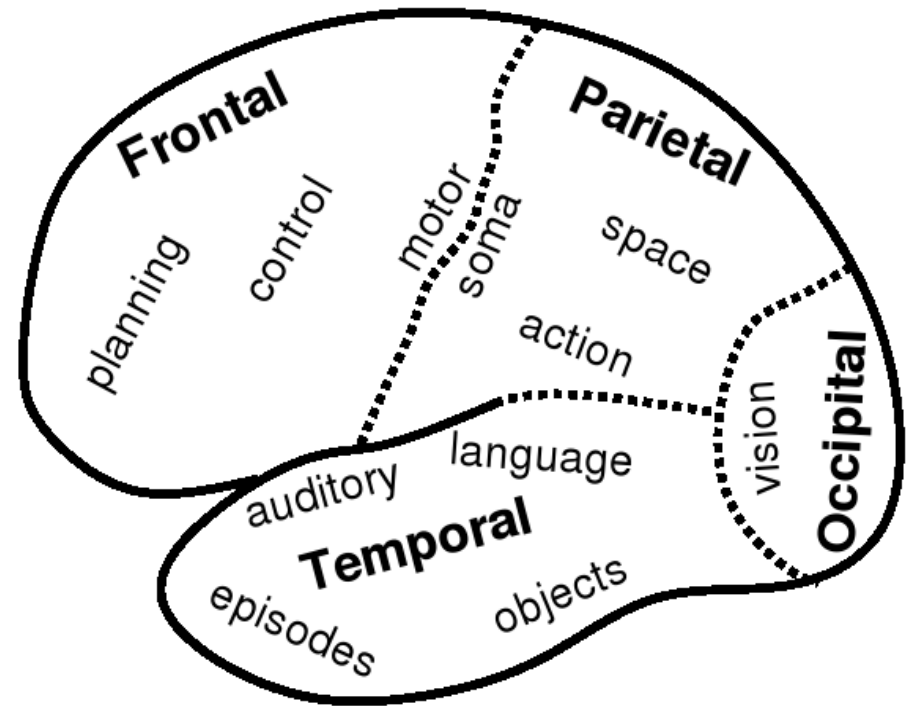
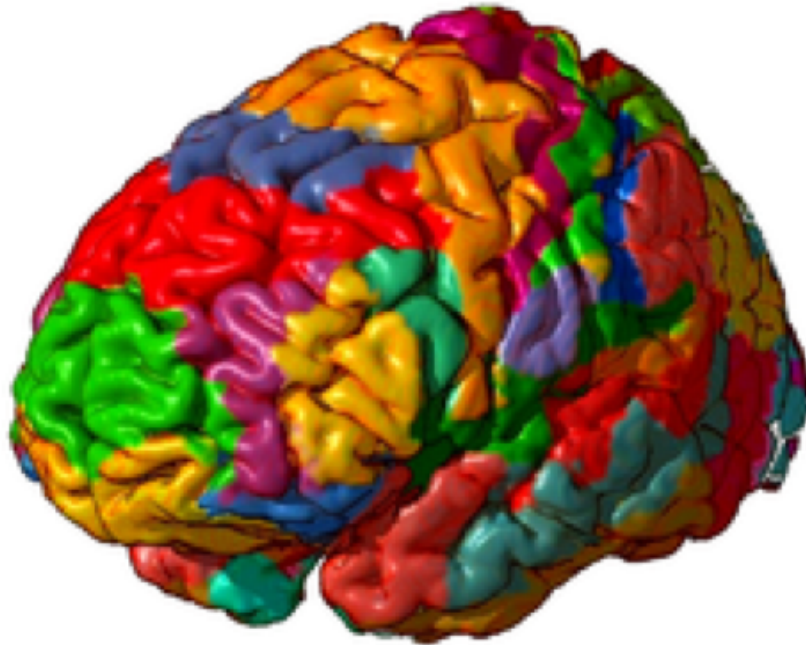

(how is this determined?)

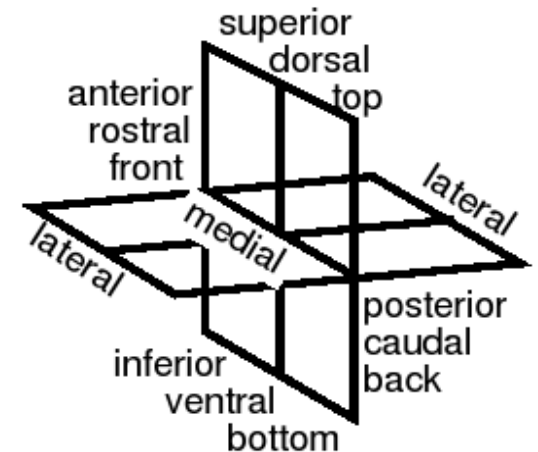

Hierarchical Sequences of Transformations

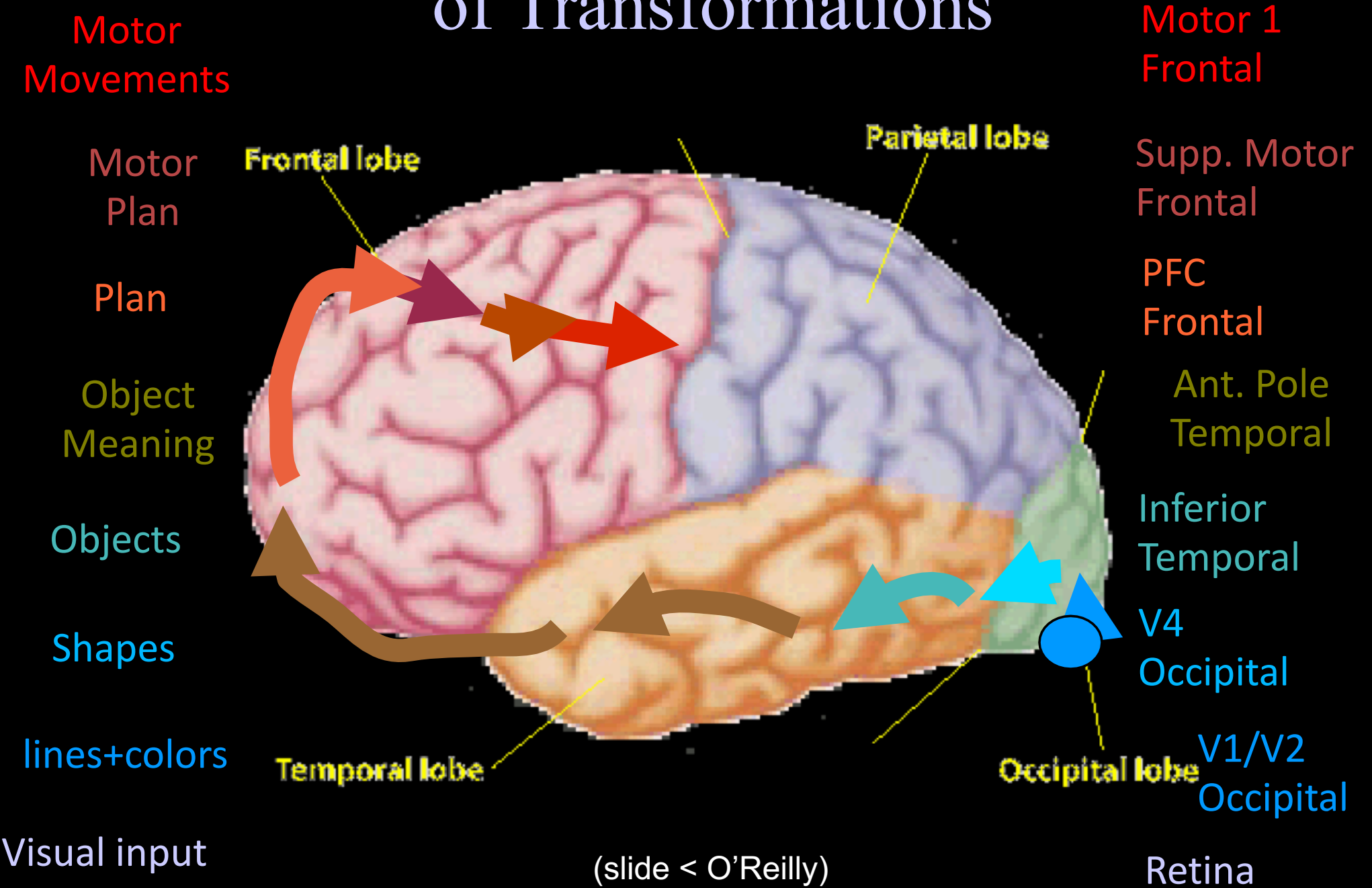

Tripartite Cognitive Architecture

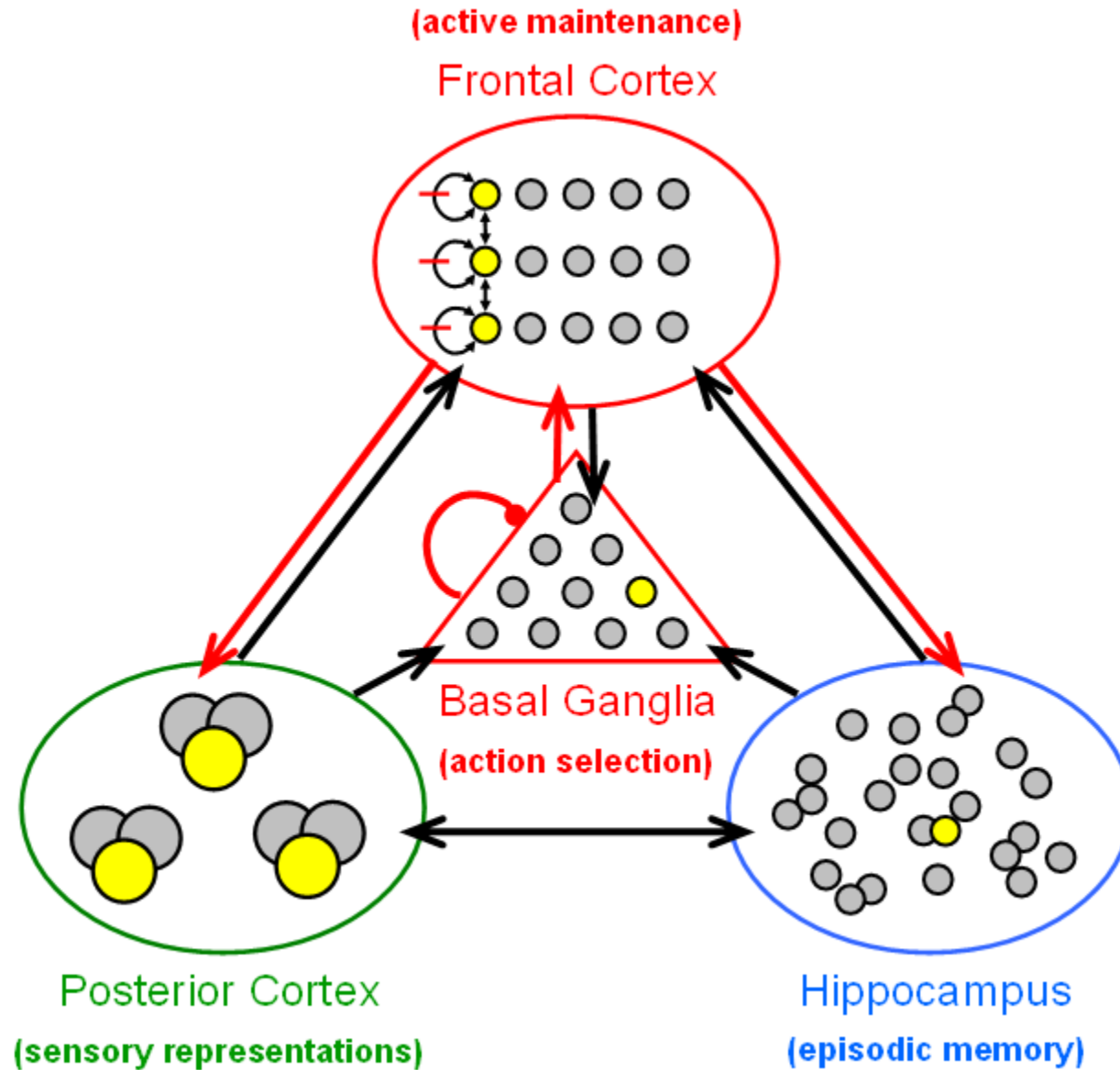

Large Scale Distributed Organizations

- Knowledge is distributed across multiple brain areas
- Multiple areas participate in representing a given thing (e.g., apple)
- Each area represents multiple things
- Same idea as distributed representation among units for individual items, but in this case across multiple areas/modalities, etc.

Learning Across the Brain

Area	Learning Signal			Dynamics		
	Reward	Error	Self Org	Separator	Integrator	Attractor
Basal Ganglia	+++	---	---	++	-	---
Cerebellum	---	+++	---	+++	---	---
Hippocampus	+	+	+++	+++	---	+++
Neocortex	++	+++	++	---	+++	+++

B. Perception and Attention

What versus Where

Hierarchy of Visual Detectors

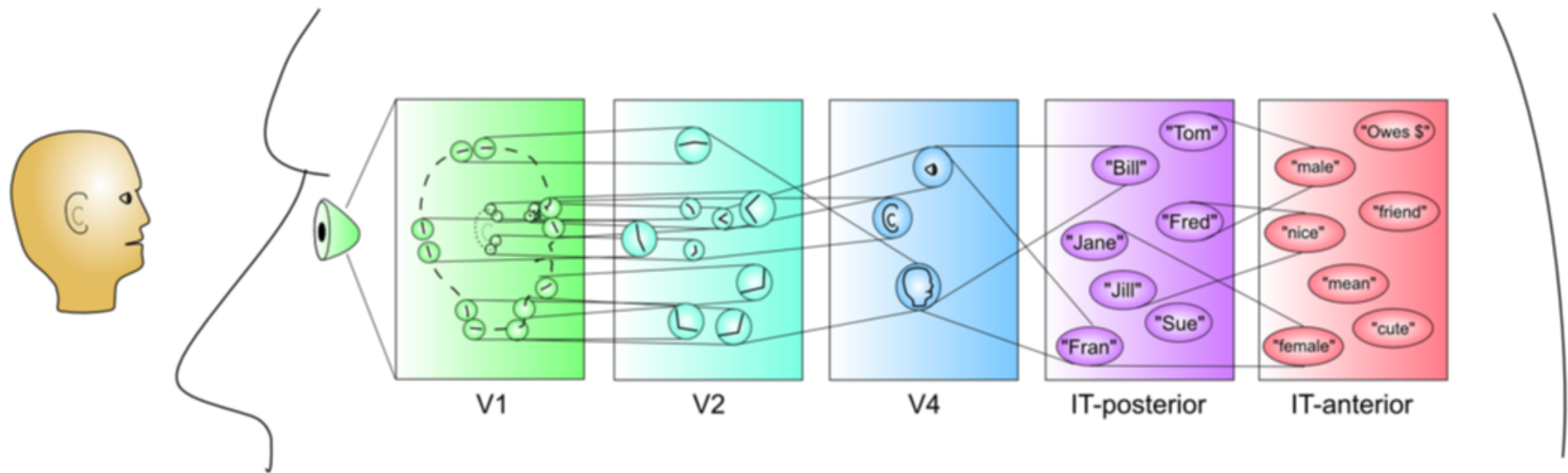

Macaque Visual System

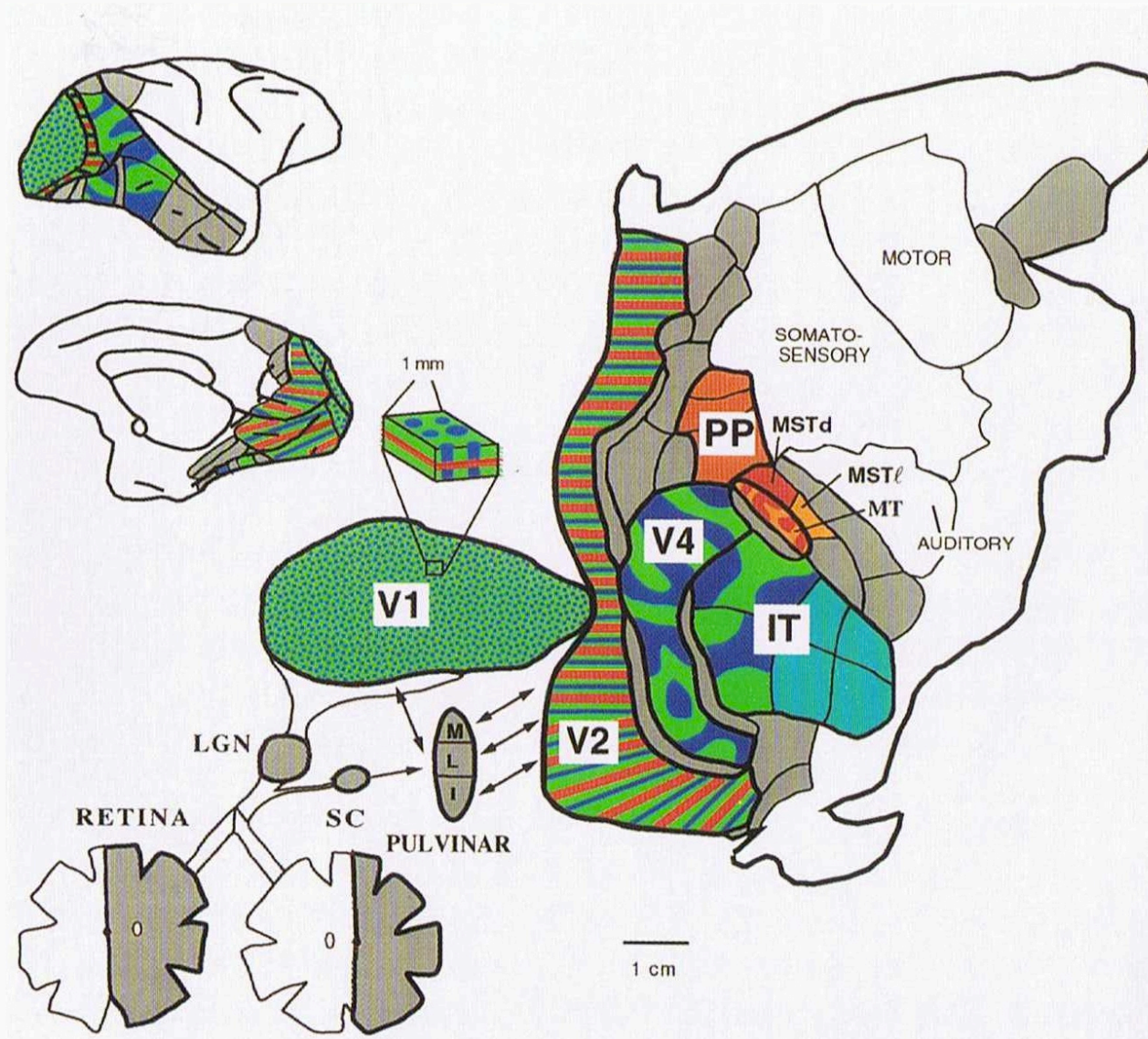

Hierarchy of Macaque Visual Areas

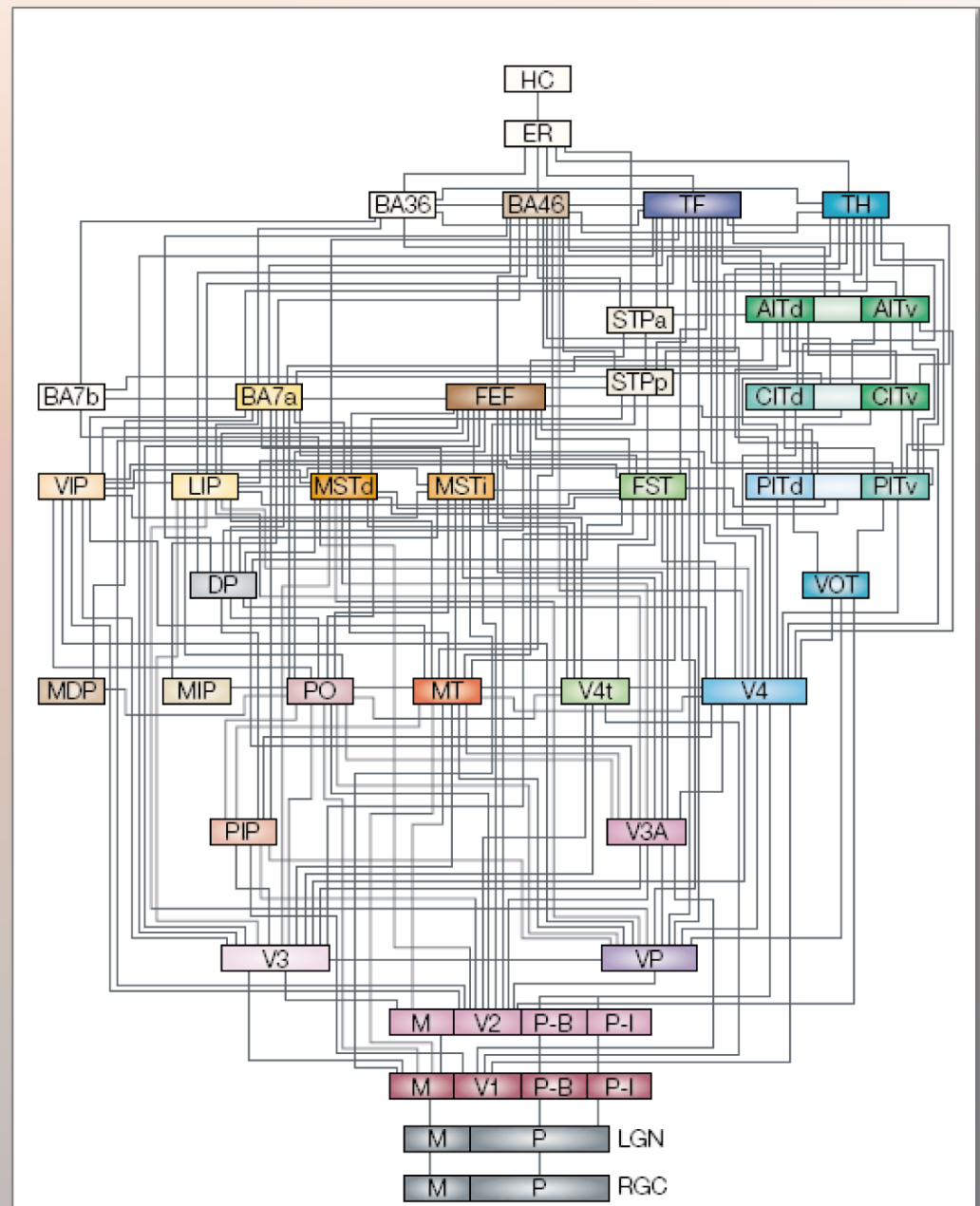

“What” vs. “Where” Pathways

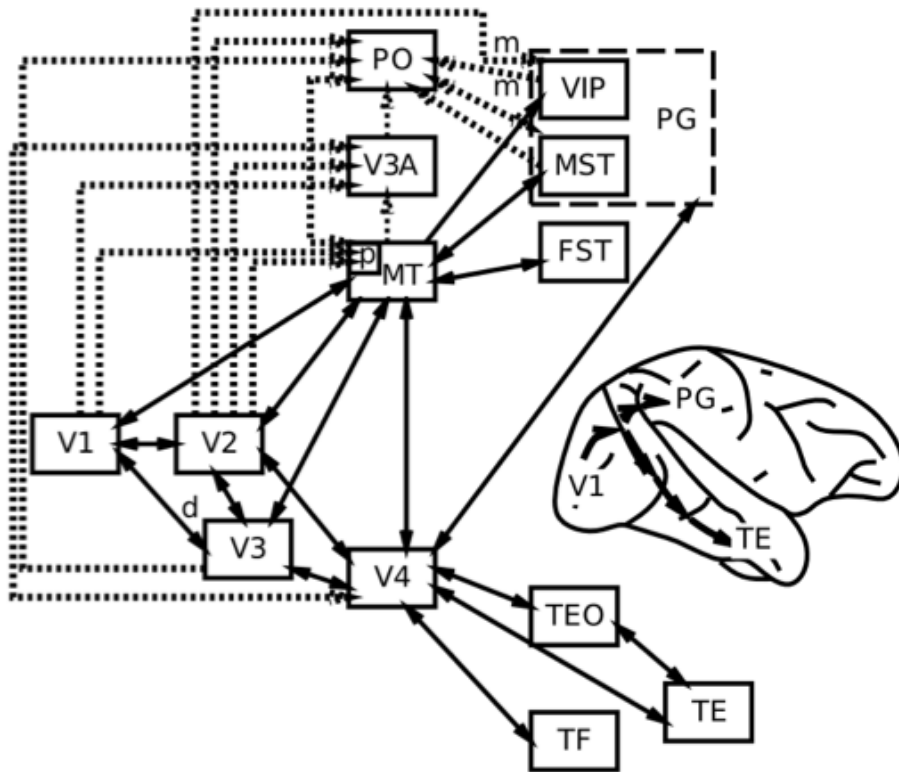

- “What” ignores differences in location, illumination, size, rotation
- “Where” emphasizes location, size, and ignores object identity

Multiple Interacting Pathways

Maintaining Abstract Information
(plans, sensory info, etc) **Movement**

Spatial Processing
Touch

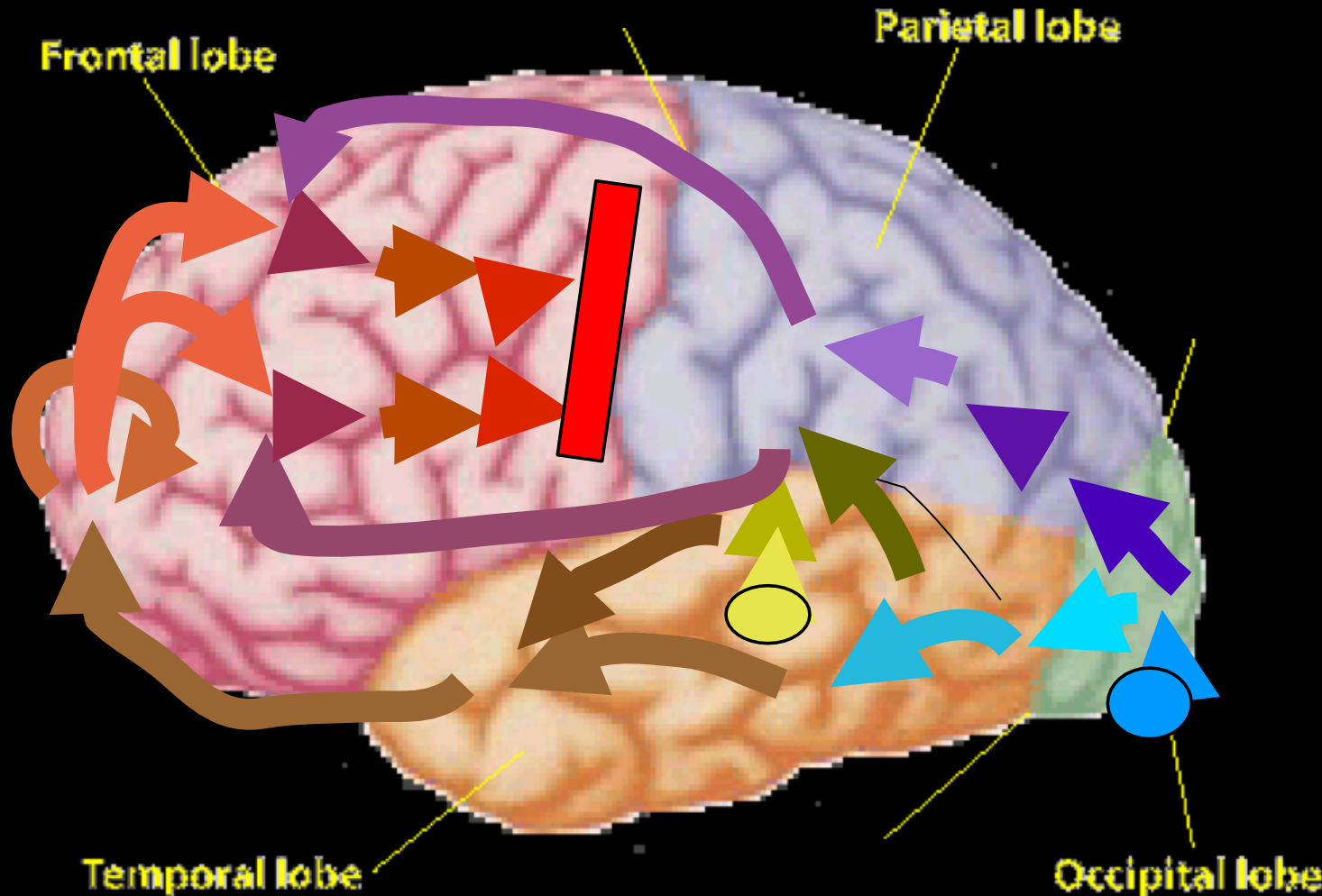

Visual Object Recognition
Audition Abstract Semantics

(slide < O'Reilly)

Early Vision

Principal Regions in “What” Pathway

Occipital Lobe

V1: Primary visual cortex

- encodes image in terms of oriented edges

V2: Secondary visual cortex

- encodes in terms of intersections & junctions

V4: Third cortical area in ventral stream

- more complex features over wider range of locations
- modulation by attention

Temporal Lobe

PIT: Posterior inferotemporal (IT) cortex

- location & size invariant object recognition

- includes FFA (fusiform face area)

AIT: Anterior IT cortex

- abstract/semantic visual information

C. Motor Control

Parietal and Motor Cortex Interacting with Basal Ganglia and Cerebellum

Motor Control

- Motor cortex (frontal to parietal)
 - high-level metrical processing of sensory information,
 - integrating multiple modalities and translating between different reference frames
 - arrives at a range of possible responses to the current sensory environment
- Basal ganglia
 - action selection: receives sensory inputs and potential responses being “considered” in frontal cortex; triggers disinhibitory signal enabling best action
 - action selection is shaped by reinforcement learning driven by dopamine signal
 - amygdala plays key role in driving these dopamine signals in response to sensory cues associated with reward and punishment
- Cerebellum
 - uses error-driven learning to acquire high-resolution metrical maps between sensory inputs and motor outputs

Somatosensory & Motor Homunculi

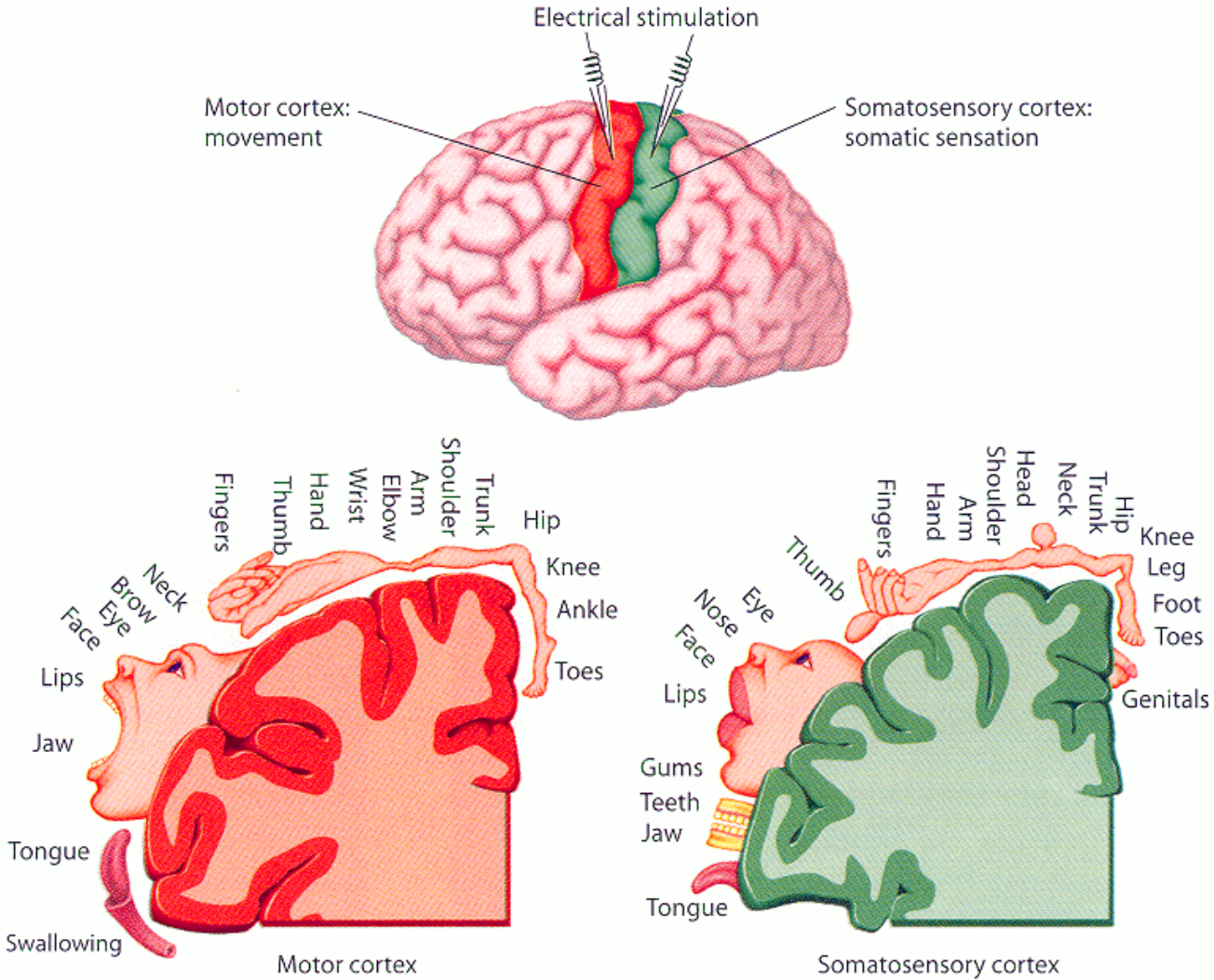

Reorganization of Cortex

A. Nerve Fields of the Hand

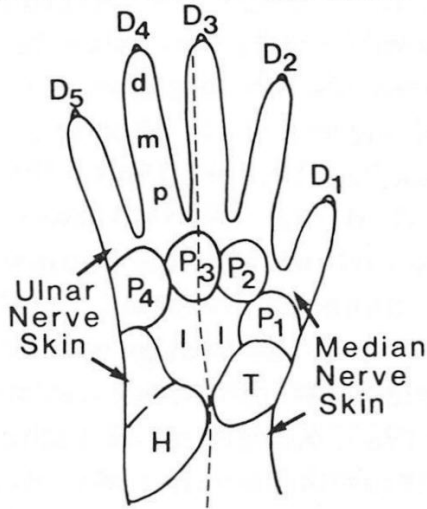

B. Topographic Pattern of Hand Representations

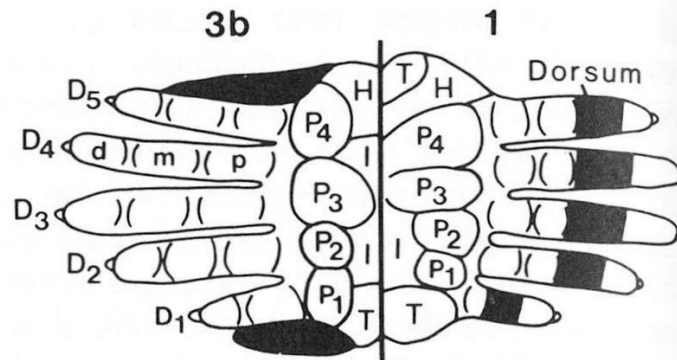

Median nerve sectioned to show fluidity of cortical organization

(C) before

(D) immediately after

(E) several months later

C. Normal Hand Representation

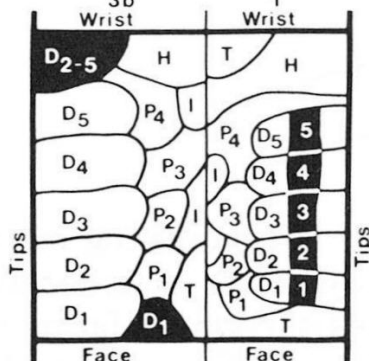

D. Cortex Deprived by Median Nerve Section

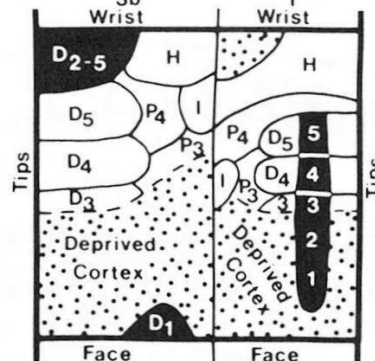

E. Fully Reorganized Cortex

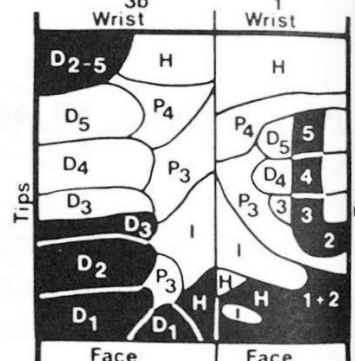

D. Learning and Memory

Temporal Cortex and the Hippocampus

Computational Trade-offs in Learning & Memory

- Computational objectives that are mutually incompatible and thus cannot be achieved by a single brain system
- Learning must be slow to capture statistical structure (averaging)
- But you have to be able to learn rapidly too
- Tradeoff solved by two systems:
 - cortex learns slowly
 - hippocampus learns rapidly
- Third system: active memory (prefrontal cortex) \approx fastest (immediately accessible)

Tripartite Functional Organization

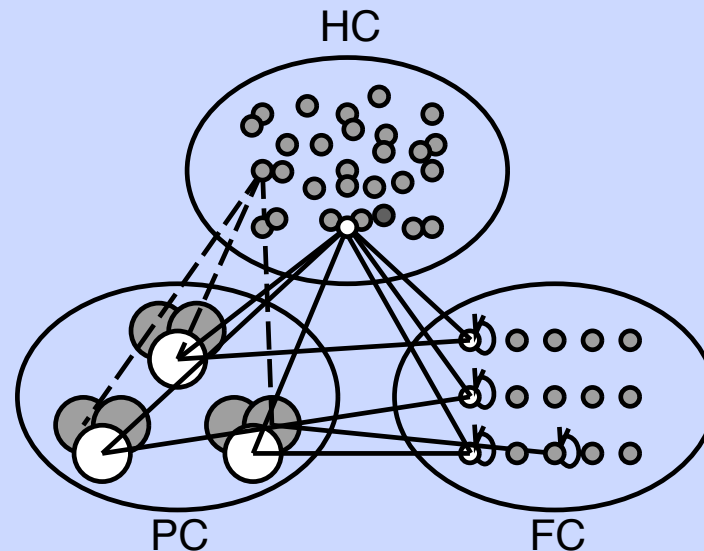

PC = posterior perceptual cortex: *slow integrative learning*

HC = hippocampus and related structures: *rapid memorization*

FC = prefrontal cortex: *active maintenance* (“working memory”)

Defined by set of functional *trade-offs*.

Hippocampal Memory Formation

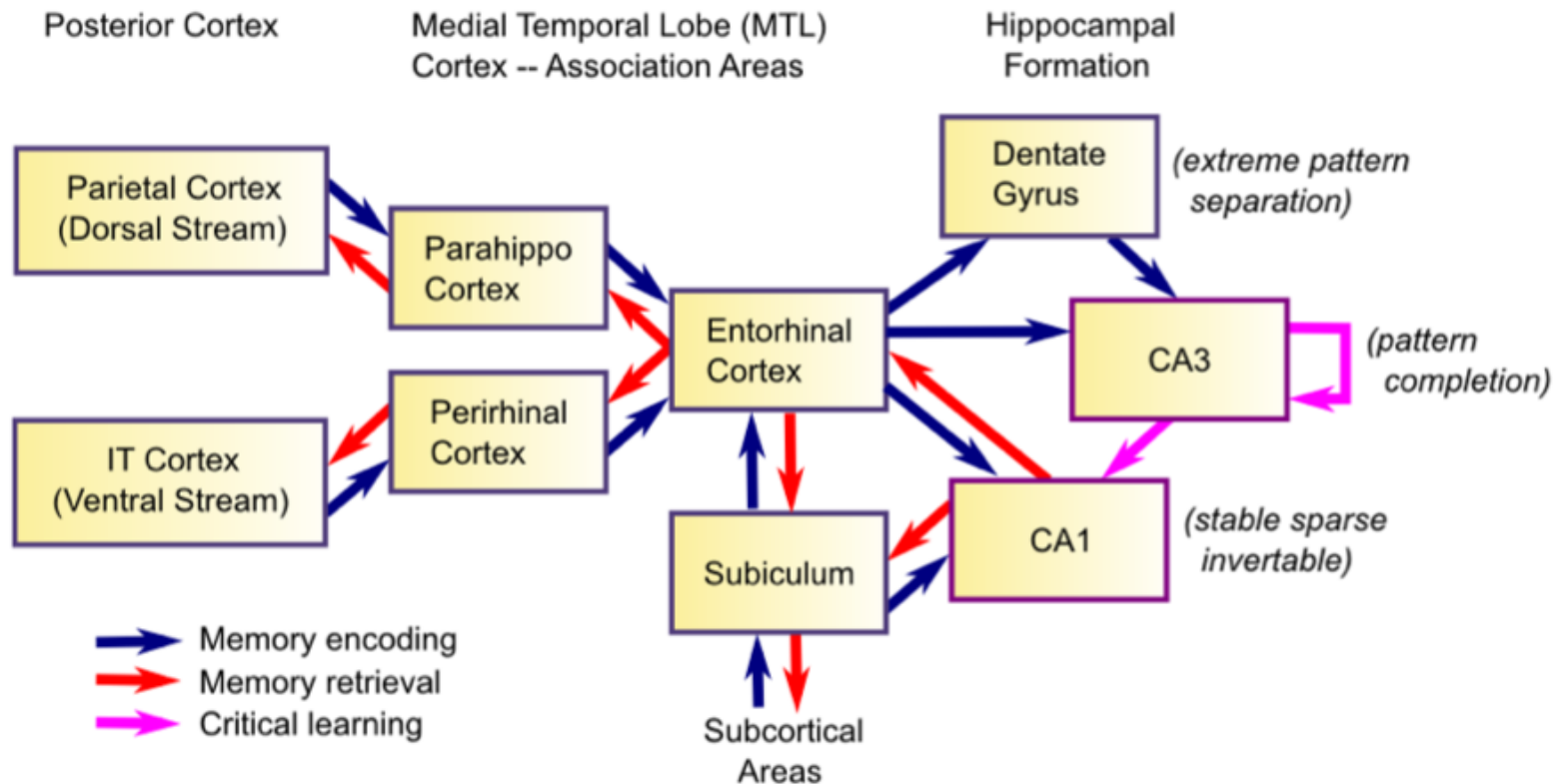

extremely sparse representations \Rightarrow pattern separation

E. Language

Language

- Involves many of the foregoing functions
 - perception, memory, executive function, motor control
- Models (ch. 9) will address:
 - small scale model of reading, incorporating orthographic, phonological, and semantic aspects
 - regular behavior without rules
 - self-organization of semantic representations
 - interaction of syntax and semantics

Distributed Representation of Words

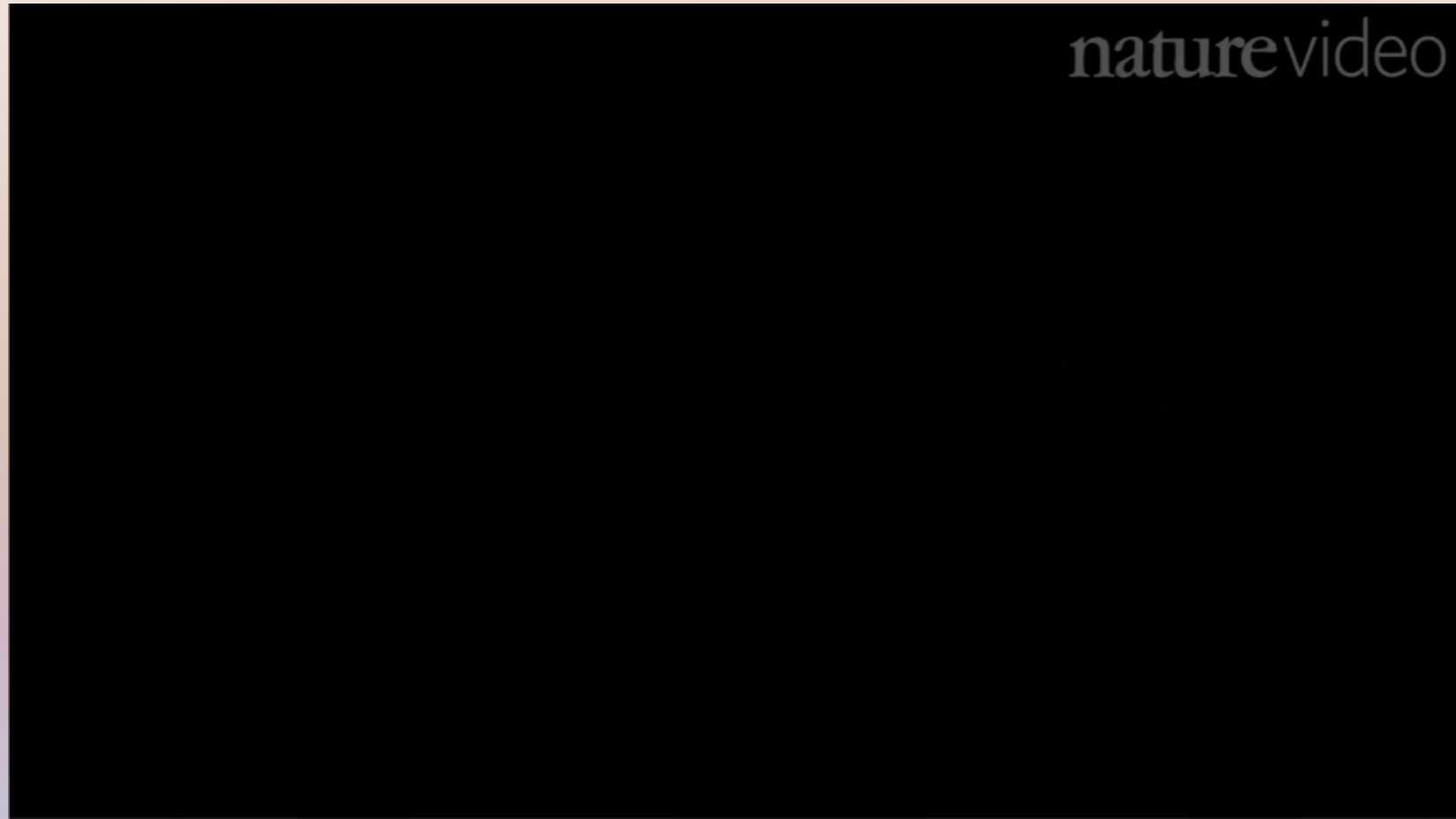

<http://http://gallantlab.org/huth2016/>

F. Executive Function

Prefrontal Cortex and Basal Ganglia

Executive Function

- Builds on motor control functions of frontal cortex (FC) and basal ganglia (BG)
- Areas of FC oriented to
 - “what” vs. “how” processing
 - “hot” emotional vs. “cold” cognitive processing
- Prefrontal cortex (PFC) control over posterior cortex
- PFC and BG interact to implement dynamically gated working memory system

Ventral vs. Dorsal Organization of PFC

