

Construction of Tank Transfer Function

Tank Input Impedance

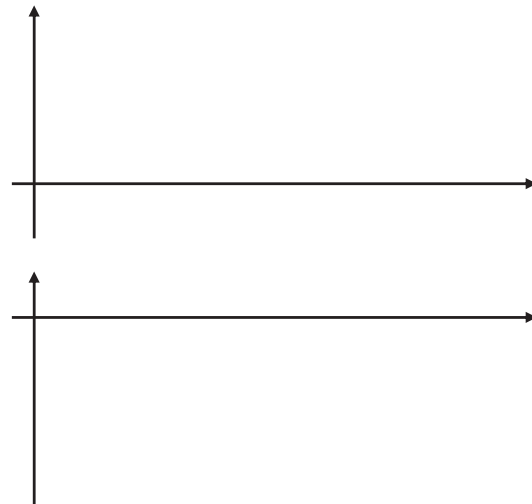

Series Resonant Tank

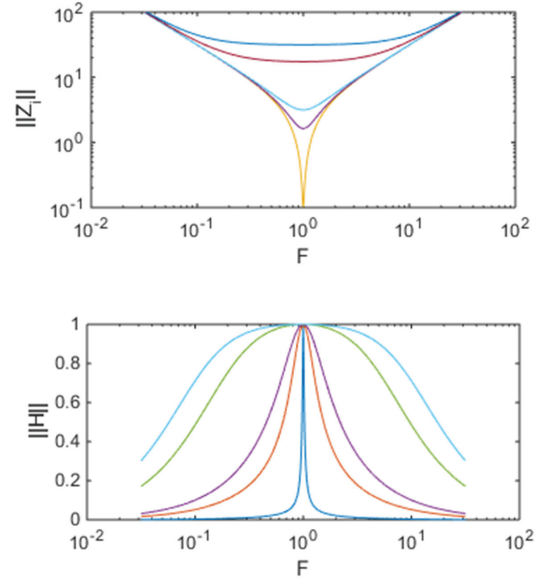

Parallel Resonant Converter

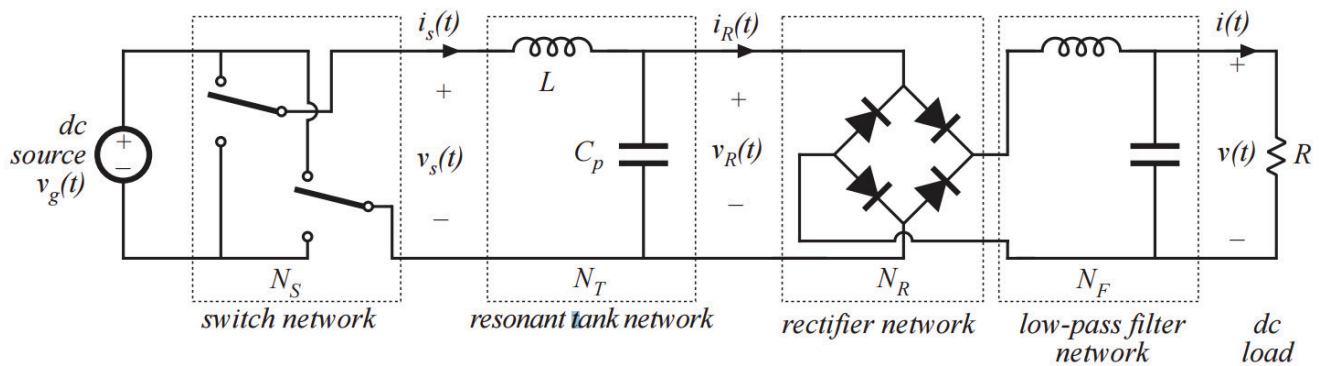

PRC Tank Input Impedance

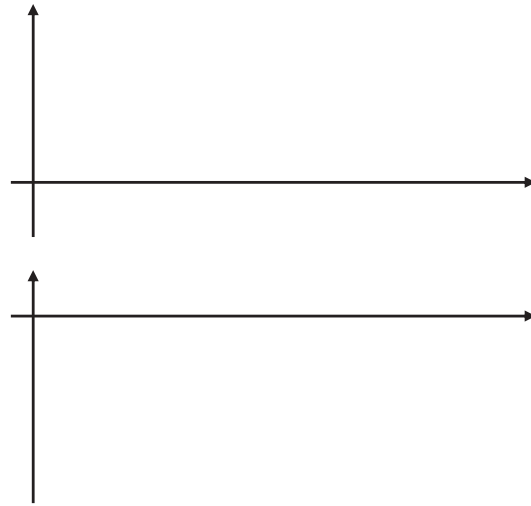
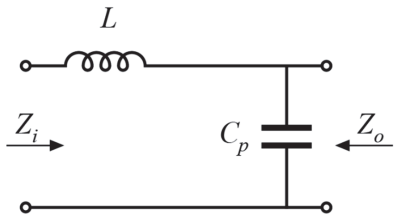

PRC Tank

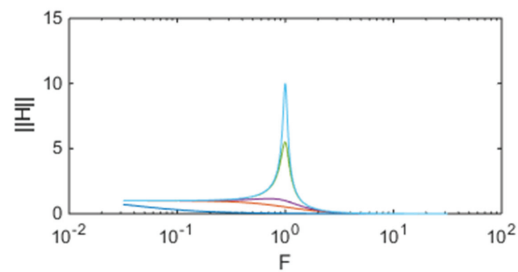
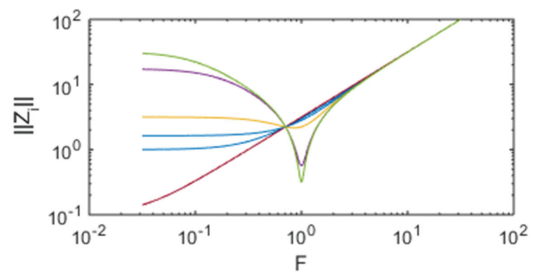

LCC

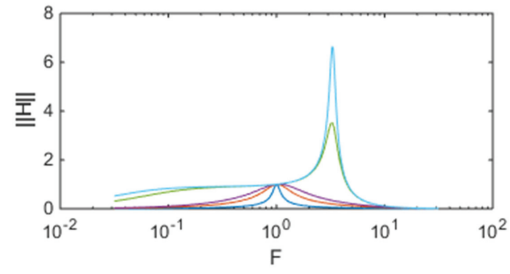
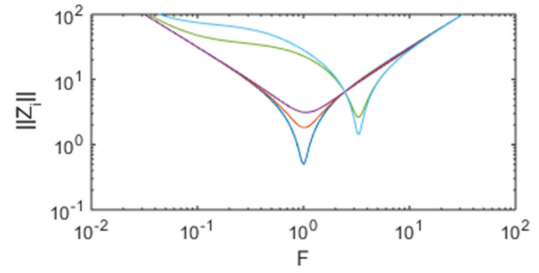
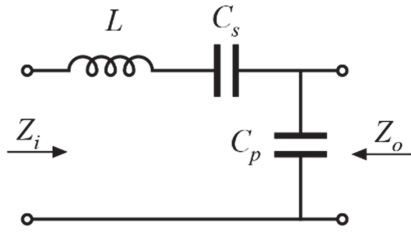

LLC

