

# A New Approach to Solving the Harmonic Elimination Equations for a Multilevel Converter

John N. Chiasson, Leon M. Tolbert, Keith J. McKenzie and Zhong Du

ECE Department

The University of Tennessee

Knoxville, TN 37996-2100

chiasson@utk.edu, tolbert@utk.edu, kmc18@utk.edu, zdu1@utk.edu

*Abstract*— A method is presented to compute the switching angles in a multilevel converter so as to produce the required fundamental voltage while at the same time not generate higher order harmonics. Previous work has shown that the transcendental equations characterizing the harmonic content can be converted to polynomial equations which are then solved using the method of resultants from elimination theory. A difficulty with this approach is that when there are several DC sources, the degrees of the polynomials are quite large making the computational burden of their resultant polynomials (as required by elimination theory) quite high. Here, it is shown that the theory of symmetric polynomials can be exploited to reduce the degree of the polynomial equations that must be solved which in turn greatly reduces the computational burden. In contrast to results reported in the literature that use iterative numerical techniques to solve these equations, the approach here produces all possible solutions.

## I. INTRODUCTION

A multilevel inverter is a power electronic device built to synthesize a desired ac voltage from several levels of dc voltages. For example, the output of solar cells are dc voltages, and if this energy is to be fed to into an ac power grid, a power electronic interface is required. A multilevel inverter is ideal for connecting such distributed dc energy sources (solar cells, fuel cells, the rectified output of wind turbines) to an existing ac power grid.

A key issue in the fundamental switching scheme is to determine the switching angles (times) so as to produce the fundamental voltage and not generate specific higher order harmonics. Here, techniques are given that allow one to control a multilevel inverter in such a way that it is an efficient, low total harmonic distortion (THD) inverter that can be used to interface distributed dc energy sources to a main ac grid or as an interface to a traction drive powered by fuel cells, batteries or ultracapacitors.

Previous work in [1][2] has shown that the transcendental equations characterizing the harmonic content can be converted into *polynomial equations* which are then solved using the method of *resultants* from *elimination theory* [3][4]. However, if there are several dc sources, the degrees of the polynomials in these equations are large. As a result, one reaches the limitations of the capability of contemporary computer algebra software tools (e.g., MATHEMATICA or MAPLE) to solve the system of polynomial equations using elimination theory (by computing the resultant polynomial of the system).

A major distinction between the work in [1][2] and the work presented here is that here it is shown how the theory of *symmetric polynomials* [3] can be exploited to reduce the degree of the polynomial equations that must be solved so that they are well within the capability of existing computer algebra software tools. As in [2], the approach here produces all possible solutions in contrast to iterative numerical techniques that have been used to solve the harmonic elimination equations (see e.g., [5]). Further, much more extensive experimental work is reported here. Specifically, the three phase multilevel inverter was connected to an induction motor and the resulting voltage and current waveforms were collected and their corresponding FFTs computed to show agreement with predicted values.

## II. CASCADED H-BRIDGES

A cascade multilevel inverter consists of a series of H-bridge (single-phase full-bridge) inverter units. The general function of this multilevel inverter is to synthesize a desired voltage from several separate dc sources (SDCSs), which may be obtained from solar cells, fuel cells, batteries, ultracapacitors, etc. Figure 1 shows a single-phase structure of a cascade inverter with SDCSs [6]. Each SDCS is connected to a single-phase full-bridge inverter. Each inverter level can generate three different voltage outputs,  $+V_{dc}$ , 0 and  $-V_{dc}$  by connecting the dc source to the ac output side by different combinations of the four switches,  $S_1, S_2, S_3$  and  $S_4$ . The ac output of each level's full-bridge inverter is connected in series such that the synthesized voltage waveform is the sum of all of the individual inverter outputs. The number of output phase voltage levels in a cascade multilevel inverter is then  $2s + 1$ , where  $s$  is the number of dc sources. An example phase voltage waveform for an 11-level cascaded multilevel inverter with five SDCSs ( $s = 5$ ) and five full bridges is shown in Figure 2. The output phase voltage is given by  $v_{an} = v_{a1} + v_{a2} + v_{a3} + v_{a4} + v_{a5}$ .

With enough levels and an *appropriate* switching algorithm, the multilevel inverter results in an output voltage that is almost sinusoidal. For the 11-level example shown in Figure 2, the waveform has less than 5% THD with each of the H-bridges' active devices switching only at the fundamental frequency. Each H-bridge unit generates a quasi-square waveform by phase-shifting its positive and negative phase legs' switching timings. Each switching device always conducts for  $180^\circ$  (or  $\frac{1}{2}$  cycle) regardless of the

pulse width of the quasi-square wave so that this switching method results in equalizing the current stress in each active device.

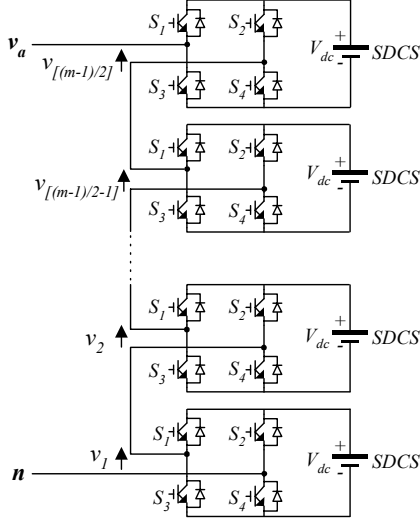

Fig. 1. Single-phase structure of a multilevel cascaded H-bridges inverter.

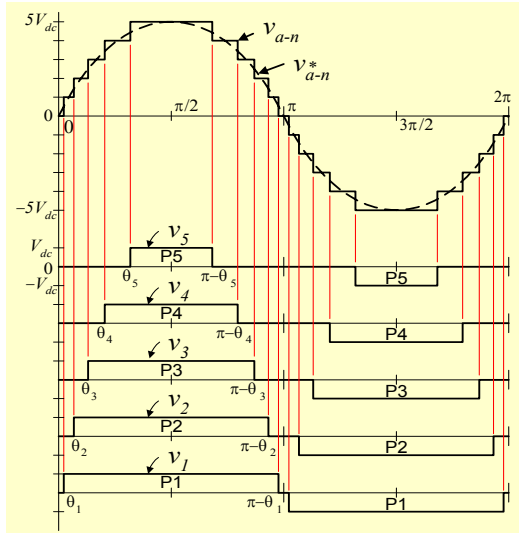

Fig. 2. Output waveform of an 11-level cascade multilevel inverter.

### III. MATHEMATICAL MODEL OF SWITCHING FOR THE MULTILEVEL CONVERTER

Following the development in [2] (see also [7][8][9]), the Fourier series expansion of the (staircase) output voltage waveform of the multilevel inverter as shown in Figure 2 is

$$V(\omega t) = \sum_{n=1,3,5,\dots}^{\infty} \frac{4V_{dc}}{n\pi} (\cos(n\theta_1) + \dots + \cos(n\theta_s)) \sin(n\omega t) \quad (1)$$

where  $s$  is the number of dc sources. Ideally, given a desired fundamental voltage  $V_1$ , one wants to determine the switching angles  $\theta_1, \dots, \theta_s$  so that (1) becomes  $V(\omega t) =$

$V_1 \sin(\omega t)$ . In practice, one is left with trying to do this approximately. The goal here is to choose the switching angles  $0 \leq \theta_1 < \theta_2 < \dots < \theta_s \leq \pi/2$  so as to make the first harmonic equal to the desired fundamental voltage  $V_1$  and specific higher harmonics of  $V(\omega t)$  equal to zero. As the application of interest here is a three-phase system, the triplen harmonics in each phase need not be canceled as they automatically cancel in the line-to-line voltages. Specifically, in case of  $s = 5$  dc sources, the desire is to cancel the  $5^{th}, 7^{th}, 11^{th}, 13^{th}$  order harmonics as they dominate the total harmonic distortion. The mathematical statement of these conditions is then

$$\begin{aligned} \frac{4V_{dc}}{\pi} (\cos(\theta_1) + \cos(\theta_2) + \dots + \cos(\theta_5)) &= V_1 \\ \cos(5\theta_1) + \cos(5\theta_2) + \dots + \cos(5\theta_5) &= 0 \\ \cos(7\theta_1) + \cos(7\theta_2) + \dots + \cos(7\theta_5) &= 0 \quad (2) \\ \cos(11\theta_1) + \cos(11\theta_2) + \dots + \cos(11\theta_5) &= 0 \\ \cos(13\theta_1) + \cos(13\theta_2) + \dots + \cos(13\theta_5) &= 0. \end{aligned}$$

This is a system of five transcendental equations in the five unknowns  $\theta_1, \theta_2, \theta_3, \theta_4, \theta_5$ . The question here is ‘‘When does the set of equations (2) have a solution?’’. The correct solution to the conditions (2) would mean that the output voltage of the 11-level inverter would not contain the  $5^{th}, 7^{th}, 11^{th}$  and  $13^{th}$  order harmonic components. One approach to solving this set of nonlinear transcendental equations (2) is to use an iterative method such as the Newton-Raphson method [7][8]. In contrast to iterative methods, here a new approach is considered that gives all possible solutions and requires significantly less computational effort than the approach in [2]. To proceed with the new methodology, first let  $s = 5$ , and define  $x_i = \cos(\theta_i)$  for  $i = 1, \dots, 5$ . Using standard trigonometric identities ( $\cos(5\theta) = 5\cos(\theta) - 20\cos^3(\theta) + 16\cos^5(\theta)$ , etc.), the conditions (2) become

$$\begin{aligned} p_1(x) &\triangleq x_1 + x_2 + x_3 + x_4 + x_5 - m = 0 \\ p_5(x) &\triangleq \sum_{i=1}^5 (5x_i - 20x_i^3 + 16x_i^5) = 0 \\ p_7(x) &\triangleq \sum_{i=1}^5 (-7x_i + 56x_i^3 - 112x_i^5 + 64x_i^7) = 0 \\ p_{11}(x) &\triangleq \sum_{i=1}^5 (-11x_i + 220x_i^3 - 1232x_i^5 + 2816x_i^7 \\ &\quad - 2816x_i^9 + 1024x_i^{11}) = 0 \\ p_{13}(x) &\triangleq \sum_{i=1}^5 (13x_i - 364x_i^3 + 2912x_i^5 - 9984x_i^7 + 16640x_i^9 \\ &\quad - 13312x_i^{11} + 4096x_i^{13}) = 0 \end{aligned} \quad (3)$$

where  $x = (x_1, x_2, x_3, x_4, x_5)$  and  $m \triangleq V_1 / (4V_{dc}/\pi)$ . The modulation index is  $m_a = m/s = V_1 / (s4V_{dc}/\pi)$  (Each inverter has a dc source of  $V_{dc}$  so that the maximum output voltage of the multilevel inverter is  $sV_{dc}$ . A square wave of

amplitude  $sV_{dc}$  results in the maximum fundamental output possible of  $V_{1\max} = 4sV_{dc}/\pi$  so  $m_a \triangleq V_1/V_{1\max} = V_1/(s4V_{dc}/\pi) = m/s$

This is a set of five equations in the five unknowns  $x_1, x_2, x_3, x_4, x_5$ . Further, the solutions must satisfy  $0 \leq x_5 < \dots < x_2 < x_1 \leq 1$ . This development has resulted in a set of polynomial equations rather than trigonometric equations. In previous work [1][2], the authors considered the three dc source case (7 levels) and solved the corresponding system of three equations in three unknowns using elimination theory by computing the resultant polynomial of the system (see [10] where polynomial systems were also used). This procedure can be used for the four dc source case (9 levels), but requires several hours of computation on a Pentium III. However, when one goes to five dc sources (11 levels), the computations using contemporary computer algebra software tools, e.g., the **Resultant** command in MATHEMATICA [11]) on a Pentium III (512 Mb RAM) appear to reach their limit (i.e., the authors were unable to get a solution before the computer gave out memory error messages). This computational complexity is because the degrees of the polynomials are large which in turn requires the *symbolic* computation of the determinant of large  $n \times n$  matrices.

Here (cf. [2]) a new approach to solving the system (3) is presented which greatly reduces the computational burden. This is done by taking into account the symmetry of the polynomials making up the system (3). Specifically, the *theory of symmetric polynomials* [3] is exploited to obtain a new set of relatively low degree polynomials whose resultants can easily be computed using existing computer algebra software tools. Further, in contrast to results reported in the literature that use iterative numerical techniques to solve these type of equations (e.g., [5]), the approach here produces all possible solutions.

#### IV. SOLVING POLYNOMIAL EQUATIONS

For the purpose of exposition, the three source (7 level) multilevel inverter will be used to illustrate the approach. The conditions are then

$$\begin{aligned} p_1(x) &\triangleq x_1 + x_2 + x_3 - m = 0, & m &\triangleq \frac{V_1}{4V_{dc}/\pi} \\ p_5(x) &\triangleq \sum_{i=1}^3 (5x_i - 20x_i^3 + 16x_i^5) = 0 \\ p_7(x) &\triangleq \sum_{i=1}^3 (-7x_i + 56x_i^3 - 112x_i^5 + 64x_i^7) = 0. \end{aligned} \quad (4)$$

Eliminating  $x_3$  by substituting  $x_3 = m - (x_1 + x_2)$  into  $p_5, p_7$  gives

$$\begin{aligned} p_5(x_1, x_2) &= 5x_1 - 20x_1^3 + 16x_1^5 + 5x_2 - 20x_2^3 + 16x_2^5 + \\ &5(m - x_1 - x_2) - 20(m - x_1 - x_2)^3 + 16(m - x_1 - x_2)^5 \\ p_7(x_1, x_2) &= -7x_1 + 56x_1^3 - 112x_1^5 + 64x_1^7 - 7x_2 + 56x_2^3 \\ &- 112x_2^5 + 64x_2^7 - 7(m - x_1 - x_2) + 56(m - x_1 - x_2)^3 \\ &- 112(m - x_1 - x_2)^5 + 64(m - x_1 - x_2)^7 \end{aligned} \quad (5)$$

where

$$\begin{aligned} \deg_{x_1} \{p_5(x_1, x_2)\} &= 4, \deg_{x_2} \{p_5(x_1, x_2)\} = 4 \\ \deg_{x_1} \{p_7(x_1, x_2)\} &= 6, \deg_{x_2} \{p_7(x_1, x_2)\} = 6 \end{aligned} \quad (6)$$

#### A. Elimination Using Resultants

In order to explain the computational issues with finding the zero sets of polynomial systems, a brief discussion of the procedure to solve such systems is now given. The question at hand is ‘‘Given two polynomial equations  $a(x_1, x_2) = 0$  and  $b(x_1, x_2) = 0$ , how does one solve them simultaneously to eliminate (say)  $x_2$ ?’’. A systematic procedure to do this is known as *elimination theory* and uses the notion of *resultants* [3][4]. Briefly, one considers  $a(x_1, x_2)$  and  $b(x_1, x_2)$  as polynomials in  $x_2$  whose coefficients are polynomials in  $x_1$ . Then, for example, letting  $a(x_1, x_2)$  and  $b(x_1, x_2)$  have degrees 3 and 2, respectively in  $x_2$ , they may be written in the form

$$\begin{aligned} a(x_1, x_2) &= a_3(x_1)x_2^3 + a_2(x_1)x_2^2 + a_1(x_1)x_2 + a_0(x_1) \\ b(x_1, x_2) &= b_2(x_1)x_2^2 + b_1(x_1)x_2 + b_0(x_1). \end{aligned}$$

The  $n \times n$  *Sylvester* matrix, where  $n = \deg_{x_2} \{a(x_1, x_2)\} + \deg_{x_2} \{b(x_1, x_2)\} = 3 + 2 = 5$ , is defined by

$$S_{a,b}(x_1) = \begin{bmatrix} a_0(x_1) & 0 & b_0(x_1) & 0 & 0 \\ a_1(x_1) & a_0(x_1) & b_1(x_1) & b_0(x_1) & 0 \\ a_2(x_1) & a_1(x_1) & b_2(x_1) & b_1(x_1) & b_0(x_1) \\ a_3(x_1) & a_2(x_1) & 0 & b_2(x_1) & b_1(x_1) \\ 0 & a_3(x_1) & 0 & 0 & b_2(x_1) \end{bmatrix}.$$

The *resultant* polynomial is then defined by

$$r(x_1) = \text{Res} \left( a(x_1, x_2), b(x_1, x_2), x_2 \right) \triangleq \det S_{a,b}(x_1) \quad (7)$$

and is the result of solving  $a(x_1, x_2) = 0$  and  $b(x_1, x_2) = 0$  simultaneously for  $x_1$ , i.e., eliminating  $x_2$ . The point here is that as the degrees of the polynomials increase, the size of the corresponding Sylvester matrix increases, and therefore the symbolic computation of its determinant becomes much more computationally intensive.

#### B. Symmetric Polynomials

Consider once again the system of polynomial equations (5). In [2] (see also [1]) the authors computed the resultant polynomial of the pair  $\{p_5(x_1, x_2), p_7(x_1, x_2)\}$  to obtain the solutions to (4). This involved setting up a  $10 \times 10$  Sylvester matrix ( $10 = \deg_{x_2} \{p_5(x_1, x_2)\} + \deg_{x_2} \{p_7(x_1, x_2)\}$ ) and then computing its determinant to obtain the resultant polynomial  $r(x_1)$  whose degree was 22. However, as one adds more dc sources to the multilevel inverter, the degrees of the polynomials go up rapidly. For example, in the case of four dc sources, the final step of the method requires computing (symbolically) the determinant of a  $27 \times 27$  Sylvester matrix to obtain a resultant polynomial of degree 221. In the case of five sources, using this method, the authors were only able to get the system of five polynomial equations in five unknowns to reduce to three equations in

three unknowns. The computation to get it down to two equations in two unknowns requires the symbolic computation of the determinant of a  $33 \times 33$  Sylvester matrix. This was attempted on a PC Pentium III (512 Mb RAM), but after several hours of computation, the computer complained of low memory and failed to produce an answer. To get around this difficulty, a new approach is developed here which exploits some special properties of symmetric polynomials.

The polynomials  $p_1(x), p_2(x), p_3(x)$  in (4) are *symmetric polynomials* [3], that is,

$$p_i(x_1, x_2, x_3) = p_i(x_{\pi(1)}, x_{\pi(2)}, x_{\pi(3)}) \text{ for all } i = 1, 2, 3$$

and any permutation  $\pi(\cdot)$ <sup>1</sup>. Define the *elementary symmetric functions* (polynomials)  $s_1, s_2, s_3$  as

$$\begin{aligned} s_1 &\triangleq x_1 + x_2 + x_3 \\ s_2 &\triangleq x_1x_2 + x_1x_3 + x_2x_3 \\ s_3 &\triangleq x_1x_2x_3. \end{aligned} \quad (8)$$

A basic theorem of symmetric polynomials is that they can be rewritten in terms of the elementary symmetric functions [3] (This is easy to do using the `SymmetricReduction` command in MATHEMATICA [11]). In the case at hand, it follows that with  $s = (s_1, s_2, s_3)$  and using (8), the polynomials (4) become

$$\begin{aligned} p_1(s) &= s_1 - m \\ p_5(s) &= 5s_1 - 20s_1^3 + 16s_1^5 + 60s_1s_2 - 80s_1^3s_2 + 80s_1s_2^2 \\ &\quad - 60s_3 + 80s_1^2s_3 - 80s_2s_3 \\ p_7(s) &= -7s_1 + 56s_1^3 - 112s_1^5 + 64s_1^7 - 168s_1s_2 \\ &\quad + 560s_1^3s_2 - 448s_1^5s_2 - 560s_1s_2^2 + 896s_1^3s_2^2 - 448s_1s_2^3 \\ &\quad + 168s_3 - 560s_1^2s_3 + 448s_1^4s_3 + 560s_2s_3 - 1344s_1^2s_2s_3 \\ &\quad + 448s_2^2s_3 + 448s_1s_2^2 \end{aligned} \quad (9)$$

One uses  $p_1(s) = s_1 - m = 0$  to eliminate  $s_1$  so that

$$\begin{aligned} q_5(s_2, s_3) &\triangleq p_5(m, s_2, s_3) \\ q_7(s_2, s_3) &\triangleq p_7(m, s_2, s_3) \end{aligned}$$

where it turns out that

$$\begin{aligned} \deg_{s_2} \{q_5(s_2, s_3)\} &= 2, \deg_{s_3} \{q_5(s_2, s_3)\} = 1 \\ \deg_{s_2} \{q_7(s_2, s_3)\} &= 3, \deg_{s_3} \{q_7(s_2, s_3)\} = 2. \end{aligned}$$

The key point here is that the degrees of these polynomials in  $s_2, s_3$  are much less than the degrees of  $p_5(x_1, x_2), p_7(x_1, x_2)$  in  $x_1, x_2$  (see (6)). In particular, the Sylvester matrix of the pair  $\{q_5(s_2, s_3), q_7(s_2, s_3)\}$  is  $3 \times 3$  (if the variable  $s_3$  is eliminated) rather than being  $10 \times 10$  in the case of  $\{p_5(x_1, x_2), p_7(x_1, x_2)\}$  in (5). Eliminating  $s_3$ , the resultant polynomial  $r_{q_5, q_7}(s_2)$  is given by

$$\begin{aligned} r_{q_5, q_7}(s_2) &\triangleq \text{Res} \left( q_5(s_2, s_3), q_7(s_2, s_3), s_3 \right) = -16m \times \\ &\left( -1575 + 9800m^2 - 24080m^4 + 28160m^6 - 15360m^8 \right. \\ &\quad + 3072m^{10} - 10500s_2 + 56000m^2s_2 - 103040m^4s_2 \\ &\quad + 78080m^6s_2 - 20480m^8s_2 - 19600s_2^2 + 89600m^2s_2^2 \\ &\quad - 116480m^4s_2^2 + 46080m^6s_2^2 - 11200s_2^3 + 44800m^2s_2^3 \\ &\quad \left. - 35840m^4s_2^3 \right) \end{aligned}$$

which is only of degree 3 in  $s_2$ . For each  $m$ , one would solve  $r_{q_5, q_7}(s_2) = 0$  for the roots  $\{s_{2i}\}_{i=1, \dots, 3}$ . These roots are then used to solve  $q_5(s_{2i}, s_3) = 0$  for the root  $s_{3i}$  resulting in the set of 3-tuples

$\{(s_1, s_2, s_3) \in \mathbb{C}^3 \mid (s_1, s_2, s_3) = (m, s_{2i}, s_{3i})_{i=1, \dots, 3}\}$  as the only possible solutions to (9).

### C. Solving the Symmetric Polynomials

For each solution triple  $(s_1, s_2, s_3)$ , the corresponding values of  $(x_1, x_2, x_3)$  are required to obtain the switching angles. Consequently, the system of polynomial equations (8) must be solved for the  $x_i$ . To do so, one simply uses the resultant method to solve the system of polynomials

$$\begin{aligned} f_1(x_1, x_2, x_3) &= s_1 - (x_1 + x_2 + x_3) = 0 \\ f_2(x_1, x_2, x_3) &= s_2 - (x_1x_2 + x_1x_3 + x_2x_3) = 0 \\ f_3(x_1, x_2, x_3) &= s_3 - x_1x_2x_3 = 0. \end{aligned}$$

That is, one computes

$$\begin{aligned} r_1(x_2, x_3) &= \text{Res} \left( f_1(x_1, x_2, x_3), f_2(x_1, x_2, x_3), x_1 \right) \\ &= -s_2 + s_1x_2 - x_2^2 + s_1x_3 - x_2x_3 - x_3^2 \\ r_2(x_2, x_3) &= \text{Res} \left( f_1(x_1, x_2, x_3), f_3(x_1, x_2, x_3), x_1 \right) \\ &= -s_3 + s_1x_2x_3 - x_2^2x_3 - x_2x_3^2 \end{aligned}$$

so that

$$\begin{aligned} r(x_3) &= \text{Res} \left( r_1(x_2, x_3), r_2(x_2, x_3), x_2 \right) \\ &= (s_3 - s_2x_3 + s_1x_3^2 - x_3^3)^2. \end{aligned} \quad (10)$$

The procedure is to substitute the solutions of (9) into (10) and solve for the roots  $\{x_{3i}\}$ . For each  $x_{3i}$ , one then solves  $r_1(x_2, x_{3i})$  for the roots  $x_{2j}$ . Finally, one solves  $f_1(x_1, x_{2j}, x_{3i}) = 0$  for  $x_{1j}$  to get the triples  $\{(x_1, x_2, x_3) = (x_{1j}, x_{2j}, x_{3i}), i = 1, 2, 3, j = 1, 2\}$  as the only possible solutions to (4). This finite set of possible solutions can then be checked as to which are solutions of (4) satisfying  $0 \leq x_3, x_2, x_1 \leq 1$ .

## V. THE FIVE DC SOURCE CASE

In this section, the five dc source case is summarized. The polynomials  $p_1(x), p_2(x), p_3(x), p_4(x), p_5(x)$  in (3) are *symmetric polynomials*, and the *elementary symmetric*

<sup>1</sup>That is,  $p_i(x_1, x_2, x_3) = p_i(x_2, x_1, x_3) = p_i(x_3, x_2, x_1)$ , etc.

functions (polynomials)  $s_1, s_2, s_3, s_4, s_5$  are defined as

$$\begin{aligned}
s_1 &\triangleq x_1 + x_2 + x_3 + x_4 + x_5 \\
s_2 &\triangleq x_1x_2 + x_1x_3 + x_1x_4 + x_1x_5 + x_2x_3 + x_2x_4 \\
&\quad + x_2x_5 + x_3x_4 + x_3x_5 + x_4x_5 \\
s_3 &\triangleq x_1x_2x_3 + x_1x_2x_4 + x_1x_2x_5 + x_1x_3x_4 + x_1x_3x_5 \\
&\quad + x_1x_4x_5 + x_2x_3x_4 + x_2x_3x_5 + x_2x_4x_5 + x_3x_4x_5 \\
s_4 &\triangleq x_1x_2x_3x_4 + x_1x_2x_3x_5 + x_1x_2x_4x_5 + x_1x_3x_4x_5 \\
&\quad + x_2x_3x_4x_5 \\
s_5 &\triangleq x_1x_2x_3x_4x_5.
\end{aligned}$$

Rewriting the polynomials  $p_i(x)$  in terms of the elementary symmetric polynomials gives

$$\begin{aligned}
p_1(s) &= s_1 - m = 0 & (11) \\
p_5(s) &= 5s_1 - 20s_1^3 + 16s_1^5 + 60s_1s_2 - 80s_1^3s_2 + 80s_1s_2^2 \\
&\quad - 60s_3 + 80s_1^2s_3 - 80s_2s_3 - 80s_1s_4 + 80s_5 = 0 & (12) \\
p_7(s) &= -7s_1 + 56s_1^3 - 112s_1^5 + 64s_1^7 + \dots = 0 & (13) \\
p_{11}(s) &= -11s_1 + 220s_1^3 - 1232s_1^5 + \dots = 0 & (14) \\
p_{13}(s) &= 13s_1 - 364s_1^3 + 2912s_1^5 \dots = 0 & (15)
\end{aligned}$$

where the complete expressions for  $p_{11}(s)$  and  $p_{13}(s)$  are given in the Appendix. One uses  $p_1(s) = s_1 - m = 0$  to eliminate  $s_1$  so that

$$\begin{aligned}
q_5(s_2, s_3, s_4, s_5) &\triangleq p_5(m, s_2, s_3, s_4, s_5) \\
q_7(s_2, s_3, s_4, s_5) &\triangleq p_7(m, s_2, s_3, s_4, s_5) \\
q_{11}(s_2, s_3, s_4, s_5) &\triangleq p_{11}(m, s_2, s_3, s_4, s_5) \\
q_{13}(s_2, s_3, s_4, s_5) &\triangleq p_{13}(m, s_2, s_3, s_4, s_5)
\end{aligned}$$

where

	degree in $s_2$	degree in $s_3$	degree in $s_4$	degree in $s_5$
$q_5(s)$	2	1	1	1
$q_7(s)$	3	2	1	1
$q_{11}(s)$	5	3	2	2
$q_{13}(s)$	6	4	3	2

The key point here is that the maximum degrees of each of these polynomials in  $s_2, s_3, s_4, s_5$  are much less than the maximum degrees of  $p_1(x), p_5(x), p_7(x), p_{11}(x), p_{13}(x)$  in  $x_1, x_2, x_3, x_4, x_5$  as seen by comparing with their values given in the table below.

	degree in $x_1, x_2, x_3, x_4, x_5$
$p_5(x_1, x_2, x_3, x_4, x_5)$	5
$p_7(x_1, x_2, x_3, x_4, x_5)$	7
$p_{11}(x_1, x_2, x_3, x_4, x_5)$	11
$p_{13}(x_1, x_2, x_3, x_4, x_5)$	13

Consequently, the computational burden of finding the resultant polynomials (i.e., the determinants of the Sylvester matrices) is greatly reduced. Also, as each of the  $q_i(s)$ 's has their maximum degree in  $s_2$ , the overall computational burden is further reduced by choosing this as the variable that is *not* eliminated. Proceeding, the indeterminate  $s_5$  is

eliminated first by computing

$$\begin{aligned}
r_{q_5, q_7}(s_2, s_3, s_4) &= \text{Res}\left(q_5(s_2, s_3, s_4, s_5), q_7(s_2, s_3, s_4, s_5), s_5\right) \\
r_{q_5, q_{11}}(s_2, s_3, s_4) &= \text{Res}\left(q_5(s_2, s_3, s_4, s_5), q_{11}(s_2, s_3, s_4, s_5), s_5\right) \\
r_{q_5, q_{13}}(s_2, s_3, s_4) &= \text{Res}\left(q_5(s_2, s_3, s_4, s_5), q_{13}(s_2, s_3, s_4, s_5), s_5\right)
\end{aligned}$$

where

	degree in $s_2$	degree in $s_3$	degree in $s_4$
$r_{q_5, q_7}(s_2, s_3, s_4)$	2	2	1
$r_{q_5, q_{11}}(s_2, s_3, s_4)$	4	3	2
$r_{q_5, q_{13}}(s_2, s_3, s_4)$	5	4	2

Eliminating  $s_4$  from these three polynomials gives the two polynomials

$$\begin{aligned}
r_1(s_2, s_3) &\triangleq \text{Res}\left(r_{q_5, q_7}(s_2, s_3, s_4), r_{q_5, q_{11}}(s_2, s_3, s_4), s_4\right) \\
r_2(s_2, s_3) &\triangleq \text{Res}\left(r_{q_5, q_7}(s_2, s_3, s_4), r_{q_5, q_{13}}(s_2, s_3, s_4), s_4\right).
\end{aligned}$$

where

	degree in $s_2$	degree in $s_3$
$r_1(s_2, s_3)$	6	4
$r_2(s_2, s_3)$	7	3

Finally, eliminating  $s_3$  from  $r_1(s_2, s_3)$  and  $r_2(s_2, s_3)$ , one obtains the resultant polynomial

$$\begin{aligned}
r(s_2) &\triangleq \text{Res}\left(r_1(s_2, s_3), r_2(s_2, s_3), s_3\right) = Cm^{12} \times \\
&\quad (5 - 20m^2 + 16m^4) (-35 + 140m^2 - 140m^4 + 32m^6 \\
&\quad - 35s_2 + 140m^2s_2 - 112m^4s_2)^4 g(s_2)
\end{aligned}$$

where  $C$  is a constant and  $g(s_2)$  is a polynomial of degree 9. One then back solves these equations for the five tuples  $(s_1, s_2, s_3, s_4, s_5)$  that are solutions to the system of polynomial equations (11)(12)(13)(14)(15).

To obtain the corresponding values of  $(x_1, x_2, x_3, x_4, x_5)$  for each of the solutions  $(s_1, s_2, s_3, s_4, s_5)$ , elimination theory is again used to solve the system of polynomial equations

$$\begin{aligned}
f_1(x_1, x_2, x_3, x_4, x_5) &= s_1 - (x_1 + x_2 + x_3 + x_4 + x_5) = 0 \\
f_2(x_1, x_2, x_3, x_4, x_5) &= s_2 - (x_1x_2 + x_1x_3 + x_1x_4 + x_1x_5 \\
&\quad + x_2x_3 + x_2x_4 + x_2x_5 + x_3x_4 + x_3x_5 + x_4x_5) = 0 \\
f_3(x_1, x_2, x_3, x_4, x_5) &= s_3 - (x_1x_2x_3 + x_1x_2x_4 + x_1x_2x_5 \\
&\quad + x_1x_3x_4 + x_1x_3x_5 + x_1x_4x_5 + x_2x_3x_4 + x_2x_3x_5 + \\
&\quad x_2x_4x_5 + x_3x_4x_5) = 0 \\
f_4(x_1, x_2, x_3, x_4, x_5) &= s_4 - (x_1x_2x_3x_4 + x_1x_2x_3x_5 \\
&\quad + x_1x_2x_4x_5 + x_1x_3x_4x_5 + x_2x_3x_4x_5) = 0 \\
f_5(x_1, x_2, x_3, x_4, x_5) &= s_5 - x_1x_2x_3x_4x_5 = 0.
\end{aligned}$$

This is done in fashion similar to that presented above for the 3 dc source case.

## VI. COMPUTATIONAL RESULTS

Using the fundamental switching scheme of Figure 2, the solutions of (2) were computed using the method described above. These solutions are plotted in Figure 3 versus the parameter  $m$ . As the plots show, for  $m$  in the intervals  $[2.21, 3.66]$  and  $[3.74, 4.23]$  as well as  $m = 1.88, 1.89$ , the output waveform can have the desired fundamental with the 5<sup>th</sup>, 7<sup>th</sup>, 11<sup>th</sup>, 13<sup>th</sup> harmonics absent. Further, in the subinterval  $[2.53, 2.9]$  two sets of solutions exist while in the subinterval  $[3.05, 3.29]$ , there are three sets of solutions. In the case of multiple solution sets, one would typically choose the set that gives the lowest total harmonic distortion (THD). In those intervals for which no solutions exist, one must use a different switching scheme. The correspond-

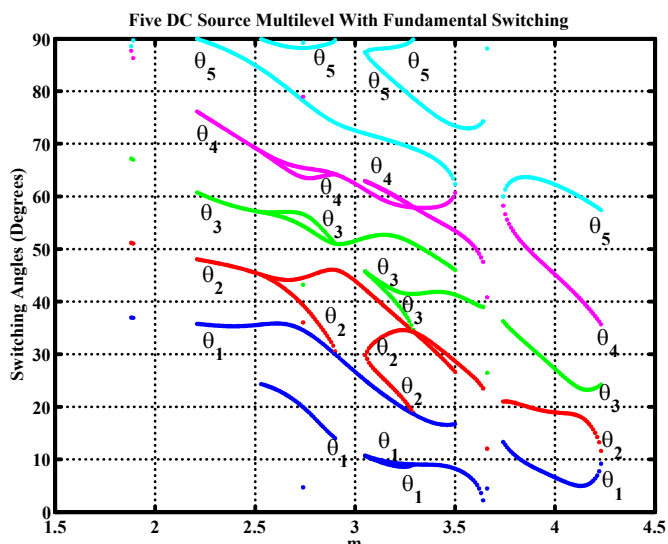

Fig. 3. Switching angles vs  $m$  for the 5 dc source multilevel converter ( $m_a = m/s$  with  $s = 5$ ).

ing total harmonic distortion (THD) was computed out to the 31<sup>st</sup> according to

$$THD = \sqrt{\frac{V_5^2 + V_7^2 + V_{11}^2 + V_{13}^2 + V_{17}^2 + \dots + V_{31}^2}{V_1^2}}$$

where  $V_i$  is the amplitude of the  $i^{th}$  harmonic term of (1). The THD versus  $m$  is plotted in Figure 4 for each of the solution sets shown in Figure 3. As this figure shows, one can choose a particular solution for the switching angles such that the THD is 6.5% or less for  $2.25 \leq m \leq 4.23$  ( $0.45 \leq m_a \leq 0.846$ ). For those values of  $m$  for which multiple solution sets exist, an appropriate choice is the one that results in the lowest THD. This was done and is shown in Figure 5. Figure 3 shows that there is a solution set for  $m$  in the interval  $[2.21, 3.66]$  that is continuous as a function of  $m$ . However, Figure 5 shows that in the subintervals  $[2.8, 2.9]$  and  $[3.11, 3.29]$ , one chooses a different solution set to obtain a smaller THD. Figure 4 shows that this difference in THD can be as much as 3.5% which is significant. If one had used an iterative method such as Newton-Raphson, then only one solution set would be

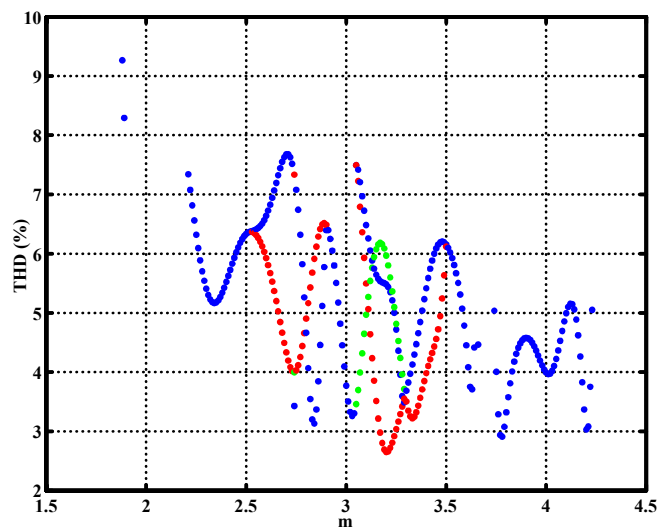

Fig. 4. The total harmonic distortion versus  $m$  for each solution set ( $m_a = m/s$  with  $s = 5$ ).

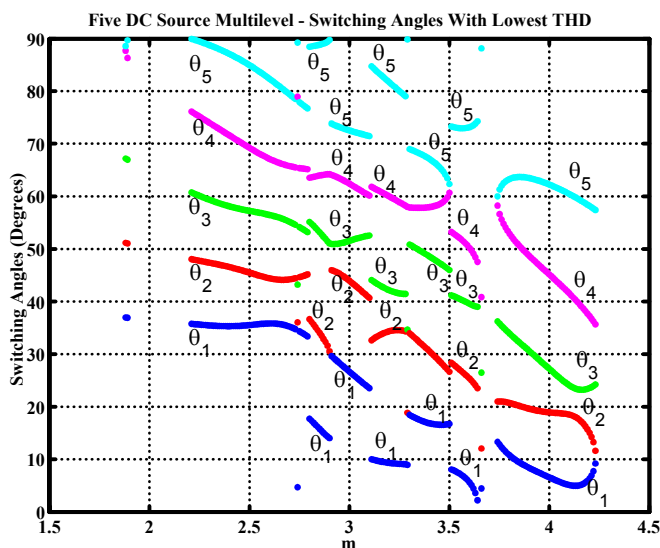

Fig. 5. The switching angles vs  $m$  which give the lowest THD for the 5 dc source multilevel converter ( $m_a = m/s$  with  $s = 5$ ).

found, and it would most certainly not be the solution set that results in the lowest THD for  $m$  in the subintervals  $[2.8, 2.9]$  and  $[3.11, 3.29]$ . The reason the Newton-Raphson method would not have found this solution set is simply due to the way it is implemented. One starts with an initial guess for the angles at  $m = 2.21$  (It would take some guessing to even know what value of  $m$  to start with!). Then the solution set for this value of  $m$  would be used as the initial guess for the solution when  $m$  is incremented by  $\Delta m$  to its next value and so on. At  $m = 2.21$ , there is only one possible solution as Figure 3 shows. Then, as  $m$  is incremented, the Newton-Raphson algorithm would give the solution set in Figure 3 that is *continuous* as a function of  $m$  which is not always the solution set with the smallest THD. In contrast, the method proposed here finds the

complete solution set and allows one to be sure that the solution with the lowest THD is used.

## VII. EXPERIMENTAL RESULTS

The experimental setup consists of a three-phase 11-level (5 dc sources) wye-connected cascaded inverter using 100 V, 70 A MOSFETs as the switching devices. A battery bank of 15 SDCSs of 36 V dc each feed the inverter (5 SDCSs per phase).

In this work, the RT-LAB real-time computing platform from *Opal-RT-Technologies Inc.* [12] was used to interface the computer (which generates the logic signals) to the gate driver board. This system allows one to implement the switching algorithm as a lookup table in SIMULINK which is then converted to C code using RTW (real-time workshop) from *Mathworks*. The RT-LAB software provides icons to interface the SIMULINK model to the digital I/O board and converts the C code into executables. The step size for the real time implementation was 32 microseconds. This small step was used to obtain an accurate resolution for implementing the switching times. Using the XHP (extreme high performance) option in RT-LAB as well as the multi-processor option to spread the computation between two processors, an execution time of 32 microseconds can be achieved. The multilevel converter was attached to a three phase induction motor with the following nameplate data: rated hp = 1/3 hp, rated current = 1.5 A, rated speed = 1725 rpm, rated voltage = 208 V (RMS line-to-line @ 60 Hz ).

### A. Experiment 1

In the first experiment,  $m = 3.2$  was chosen to produce a fundamental voltage of  $V_1 = m(4V_{dc}/\pi) = 3.2(4 \times 36/\pi) = 146.7$  V along with  $f = 60$  Hz. As can be seen in Figure 4, there are three different solution sets for  $m = 3.2$ . The solution set that gave the smallest THD ( $= 2.65\%$  see Figure 4) was used. Figure 6 shows the phase  $a$  voltage and its corresponding FFT showing that the 5<sup>th</sup>, 7<sup>th</sup>, 11<sup>th</sup> and 13<sup>th</sup> are absent from the waveform as predicted. The THD of the line-line voltage was computed using the data in Figure 6 and was found to be 2.8%, comparing favorably with the value of 2.65% predicted in Figure 4. Figure 7 contains a plot of both the phase  $a$  current and its corresponding FFT showing that the harmonic content of the current is much less than the voltage due to the filtering by the motor's inductance. The THD of this current waveform was computed using the FFT data and was found to be 1.9%.

### B. Experiment 2

In the second experiment,  $m = 3.2$  ( $V_1 = 146.7$  V) was again chosen along with  $f = 60$  Hz, but the solution set in Figure 4 with the highest THD ( $= 6.0\%$  see Figure 4) was used. The phase  $a$  output voltage waveform and its corresponding FFT are shown in Figure 8. The THD of the line-line voltage was 5.2% comparing favorably with the 6.0% predicted in Figure 4. Note that the 19<sup>th</sup> harmonic in Figure 8 is about 4% while is it zero in Figure 6. By having all the solution sets, one has the capability to choose the

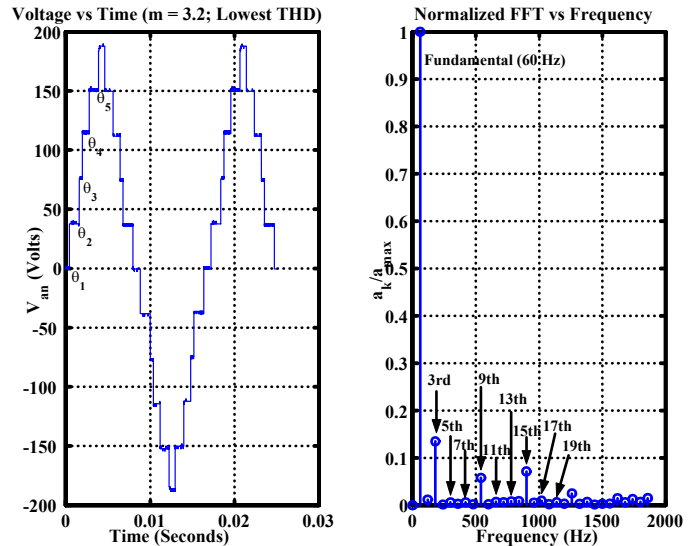

Fig. 6. Phase  $a$  output voltage waveform ( $m = 3.2$ ) using the solutions set with the lowest THD and its normalized FFT.

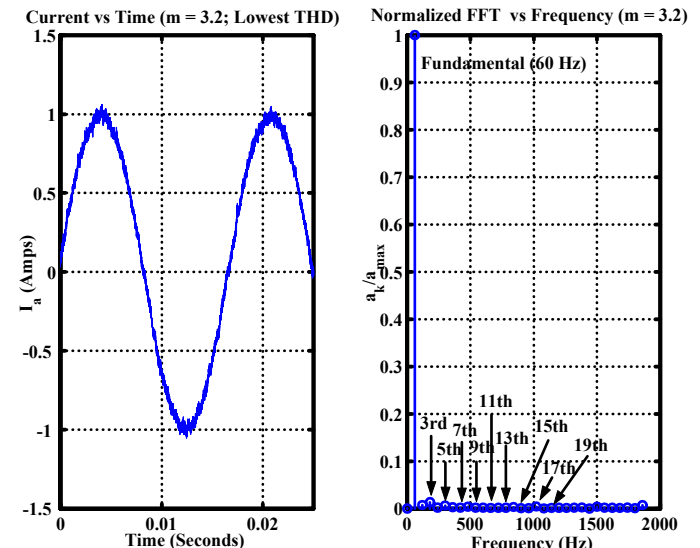

Fig. 7. Phase  $a$  current corresponding to the voltage in Figure 6 and its normalized FFT.

one with the lowest THD and, as this example shows, there can be a significant difference.

This harmonic content is also seen in the phase currents. The left side of Figure 9 is the current waveform of phase  $a$  corresponding to the voltage shown in Figure 8. The right side Figure 9 is a plot of the normalized FFT of the current waveform. Note that there is a significant 19<sup>th</sup> harmonic in the current in contrast to using the other solution set as in section VII-A where Figure 7 shows the 19<sup>th</sup> current harmonic to be zero. The THD of this current waveform was computed from the FFT data and found to be 3.3%.

## VIII. CONCLUSIONS

A procedure to eliminate harmonics in a multilevel inverter has been given which exploits the properties of the

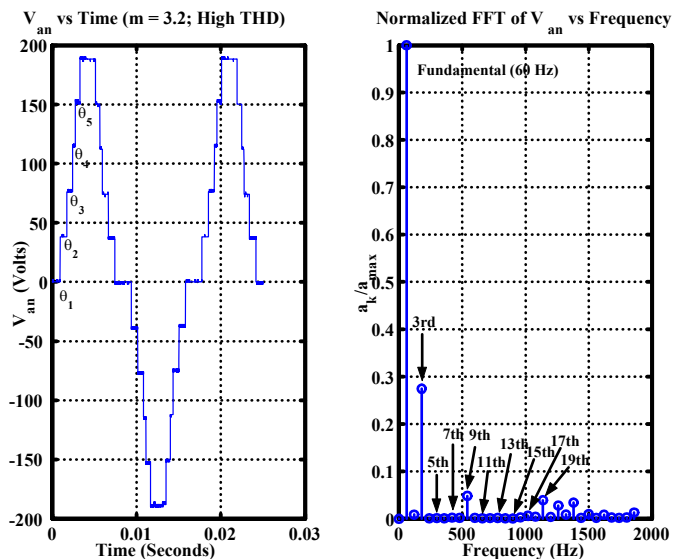

Fig. 8. Phase  $a$  output voltage waveform ( $m = 3.2$ ) using the solution set with the highest THD and its normalized FFT.

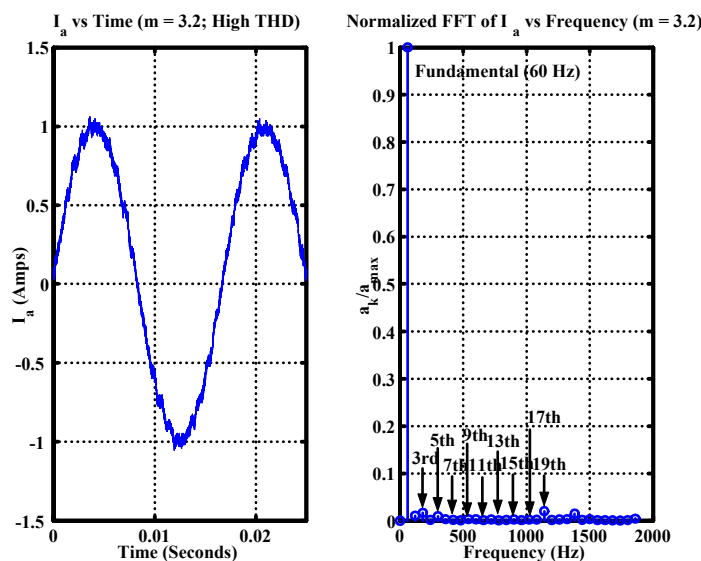

Fig. 9. Phase  $a$  current corresponding to the voltage in Figure 8 and its normalized FFT.

transcendental equations that define the harmonic content of the converter output. Specifically, it was shown that one can transform the transcendental equations into symmetric polynomials which are then further transformed into another set of polynomials in terms of the elementary symmetric functions.

This formulation resulted in a drastic reduction in the degrees of the polynomials that characterize the solution. Consequently, the computation of solutions of this final set of polynomial equations were easily carried out using elimination theory (resultants) as the required symbolic computations were well within the capabilities of contemporary computer algebra software tools.

This methodology resulted in the complete characteriza-

tion of the solutions to the harmonic elimination problem. That is, for each modulation index, it produces *all* possible solutions or it shows that no solution exists. This is in contrast to iterative numerical techniques such as Newton-Raphson, optimization software, etc. (for example, see [5],[13]) where one gets only one solution or no solution and is left to ponder whether a solution exists or not. Experiments were performed and the data presented corresponded well with the predicted results.

## IX. ACKNOWLEDGEMENTS

Dr. Tolbert would like to thank the National Science Foundation for partially supporting this work through contract NSF ECS-0093884. Drs. Chiasson and Tolbert would like to thank Oak Ridge National Laboratory for partially supporting this work through the UT/Battelle contract no. 4000007596.

## REFERENCES

- [1] J. Chiasson, L. M. Tolbert, K. McKenzie, and Z. Du, "Eliminating harmonics in a multilevel inverter using resultant theory," in *Proceedings of the IEEE Power Electronics Specialists Conference*, pp. 503–508, June 2002. Cairns, Australia.
- [2] J. Chiasson, L. M. Tolbert, K. McKenzie, and Z. Du, "Control of a multilevel converter using resultant theory," *IEEE Transactions on Control System Technology*, vol. 11, pp. 345–354, May 2003.
- [3] D. Cox, J. Little, and D. O'Shea, *IDEALS, VARIETIES, AND ALGORITHMS An Introduction to Computational Algebraic Geometry and Commutative Algebra, Second Edition*. Springer-Verlag, 1996.
- [4] Joachim von zur Gathen and Jürgen Gerhard, *Modern Computer Algebra*. Cambridge University Press, 1999.
- [5] P. N. Enjeti, P. D. Ziogas, and J. F. Lindsay, "Programmed PWM techniques to eliminate harmonics: A critical evaluation," *IEEE Transactions Industry Applications*, vol. 26, pp. 302–316, March/April 1990.
- [6] J. S. Lai and F. Z. Peng, "Multilevel converters - A new breed of power converters," *IEEE Transactions on Industry Applications*, vol. 32, pp. 509–517, May/June 1996.
- [7] L. M. Tolbert and T. G. Habetler, "Novel multilevel inverter carrier-based PWM methods," *IEEE Transactions on Industry Applications*, vol. 35, pp. 1098–1107, Sept./Oct. 1999.
- [8] L. M. Tolbert, F. Z. Peng, and T. G. Habetler, "Multilevel converters for large electric drives," *IEEE Transactions on Industry Applications*, vol. 35, pp. 36–44, Jan./Feb. 1999.
- [9] L. M. Tolbert, F. Z. Peng, and T. G. Habetler, "Multilevel PWM methods at low modulation indexes," *IEEE Transactions on Power Electronics*, vol. 15, pp. 719–725, July 2000.
- [10] J. Sun and I. Grotstollen, "Pulsewidth modulation based on real-time solution of algebraic harmonic elimination equations," in *Proceedings of the 20th International Conference on Industrial Electronics, Control and Instrumentation IECON*, vol. 1, pp. 79–84, 1994.
- [11] S. Wolfram, *Mathematica, A System for Doing Mathematics by Computer, Second Edition*. Addison-Wesley, 1992.
- [12] Opal-RT Technologies, "RTLab," 2001. See <http://www.opal-rt.com/>.
- [13] R. Lund, M. D. Manjrekar, P. Steimer, and T. A. Lipo, "Control strategies for a hybrid seven-level inverter," in *Proceedings of the European Power Electronic Conference*, September 1999. Lausanne, Switzerland.