Lecture 11: DCM Introduction

ECE 481: Power Electronics

Prof. Daniel Costinett

Department of Electrical Engineering and Computer Science

University of Tennessee Knoxville

Fall 2013

Example: Analysis of DCM buck converter $M(D,K)$

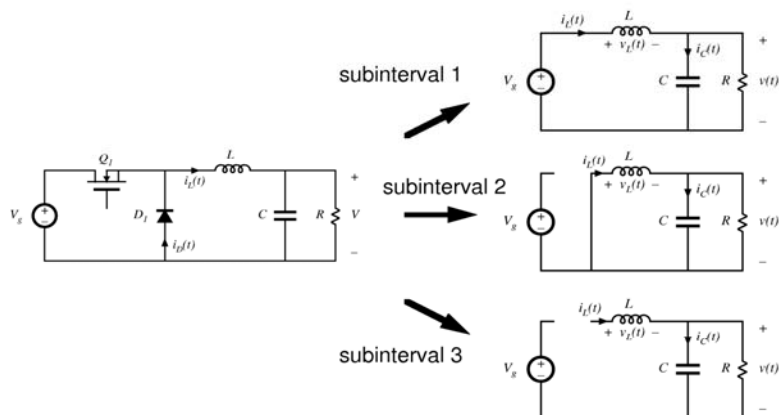

Subinterval 1

$$v_L(t) = V_g - v(t)$$
$$i_C(t) = i_L(t) - v(t) / R$$

Small ripple approximation
for $v(t)$ (but not for $i(t)$):

$$v_L(t) \approx V_g - V$$
$$i_C(t) \approx i_L(t) - V / R$$

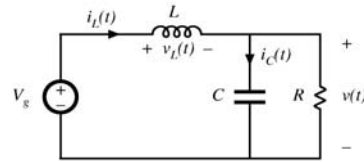

Subinterval 2

$$v_L(t) = -v(t)$$
$$i_C(t) = i_L(t) - v(t) / R$$

Small ripple approximation
for $v(t)$ but not for $i(t)$:

$$v_L(t) \approx -V$$
$$i_C(t) \approx i_L(t) - V / R$$

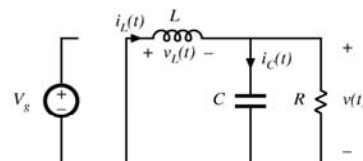

Subinterval 3

$$v_L = 0, \quad i_L = 0$$

$$i_C(t) = i_L(t) - v(t) / R$$

Small ripple approximation:

$$v_L(t) = 0$$

$$i_C(t) = -V / R$$

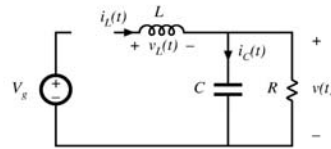

Inductor volt-second balance

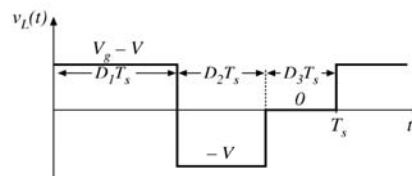

Volt-second balance:

$$\langle v_L(t) \rangle = D_1(V_g - V) + D_2(-V) + D_3(0) = 0$$

Solve for V:

$$V = V_g \frac{D_1}{D_1 + D_2} \quad \text{note that } D_2 \text{ is unknown}$$

Capacitor charge balance

node equation:

$$i_L(t) = i_C(t) + V/R$$

capacitor charge balance:

$$\langle i_C \rangle = 0$$

hence

$$\langle i_L \rangle = V/R$$

must compute dc component of inductor current and equate to load current (for this buck converter example)

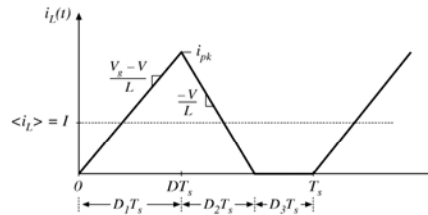
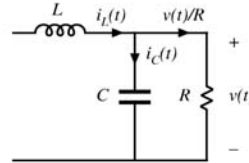

Inductor current waveform

peak current:

$$i_L(D_1 T_s) = i_{pk} = \frac{V_g - V}{L} D_1 T_s$$

average current:

$$\langle i_L \rangle = \frac{1}{T_s} \int_0^{T_s} i_L(t) dt$$

triangle area formula:

$$\int_0^{T_s} i_L(t) dt = \frac{1}{2} i_{pk} (D_1 + D_2) T_s$$

$$\langle i_L \rangle = (V_g - V) \frac{D_1 T_s}{2L} (D_1 + D_2)$$

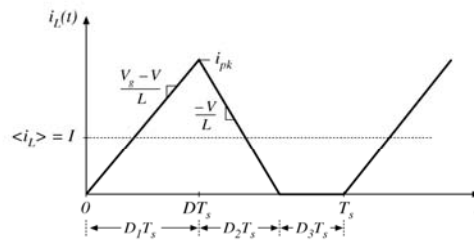

equate dc component to dc load current:

$$\frac{V}{R} = \frac{D_1 T_s}{2L} (D_1 + D_2) (V_g - V)$$

Solution for V

Two equations and two unknowns (V and D_2):

$$V = V_g \frac{D_1}{D_1 + D_2} \quad (\text{from inductor volt-second balance})$$

$$\frac{V}{R} = \frac{D_1 T_s}{2L} (D_1 + D_2) (V_g - V) \quad (\text{from capacitor charge balance})$$

Eliminate D_2 , solve for V :

$$\frac{V}{V_g} = \frac{2}{1 + \sqrt{1 + 4K / D_1^2}}$$

where $K = 2L / RT_s$

valid for $K < K_{crit}$

Buck converter $M(D,K)$

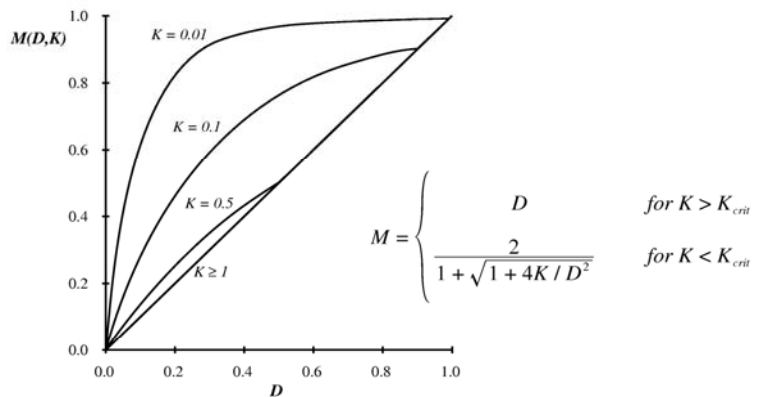

5.3. Boost converter example

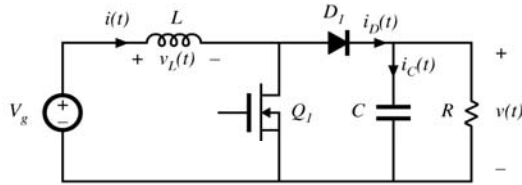

Mode boundary:

$$I > \Delta i_L \quad \text{for CCM}$$

$$I < \Delta i_L \quad \text{for DCM}$$

Previous CCM soln:

$$I = \frac{V_g}{D^2 R} \quad \Delta i_L = \frac{V_g}{2L} DT_s$$

Mode boundary

$$\frac{V_g}{D^2 R} > \frac{DT_s V_g}{2L} \quad \text{for CCM}$$

$$\frac{2L}{RT_s} > DD^2 \quad \text{for CCM}$$

$$K > K_{crit}(D) \quad \text{for CCM}$$

$$K < K_{crit}(D) \quad \text{for DCM}$$

$$\text{where } K = \frac{2L}{RT_s} \quad \text{and} \quad K_{crit}(D) = DD^2$$

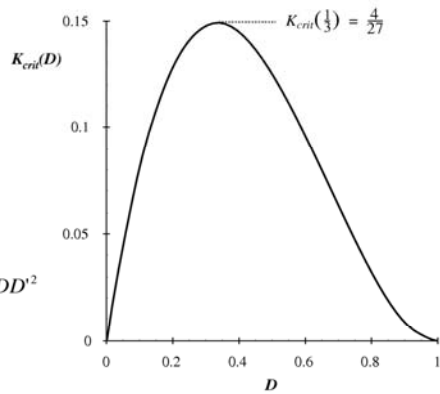

Mode boundary

$$K > K_{crit}(D) \quad \text{for CCM}$$

$$K < K_{crit}(D) \quad \text{for DCM}$$

where $K = \frac{2L}{RT_s}$ and $K_{crit}(D) = DD^2$

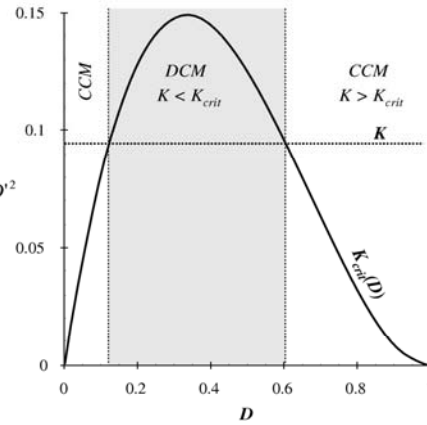

Conversion ratio: DCM boost

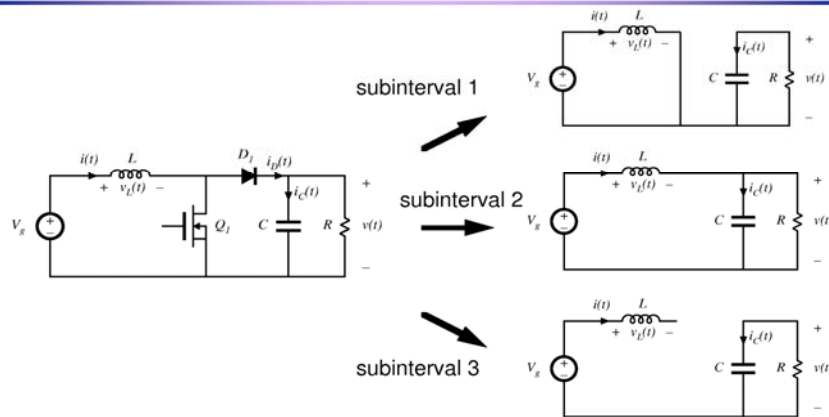

Subinterval 1

$$v_L(t) = V_g$$

$$i_C(t) = -v(t) / R$$

Small ripple approximation
for $v(t)$ (but not for $i(t)$):

$$v_L(t) \approx V_g$$

$$i_C(t) \approx -V / R$$

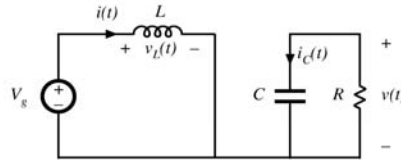

$$0 < t < D_1 T_s$$

Subinterval 2

$$v_L(t) = V_g - v(t)$$

$$i_C(t) = i(t) - v(t) / R$$

Small ripple approximation
for $v(t)$ but not for $i(t)$:

$$v_L(t) \approx V_g - V$$

$$i_C(t) \approx i(t) - V / R$$

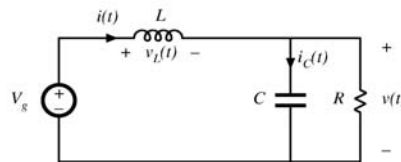

$$D_1 T_s < t < (D_1 + D_2) T_s$$

Subinterval 3

$$v_L = 0, \quad i = 0$$

$$i_C(t) = -v(t) / R$$

Small ripple approximation:

$$v_L(t) = 0$$

$$i_C(t) = -V / R$$

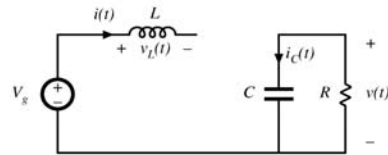

$$(D_1 + D_2)T_s < t < T_s$$

Inductor volt-second balance

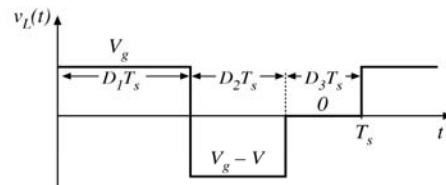

Volt-second balance:

$$D_1 V_g + D_2 (V_g - V) + D_3 (0) = 0$$

Solve for V:

$$V = \frac{D_1 + D_2}{D_2} V_g$$

note that D_2 is unknown

Capacitor charge balance

node equation:

$$i_D(t) = i_C(t) + v(t) / R$$

capacitor charge balance:

$$\langle i_C \rangle = 0$$

hence

$$\langle i_D \rangle = V / R$$

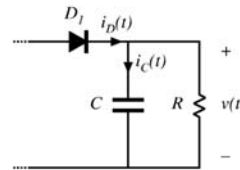

must compute dc component of diode current and equate to load current (for this boost converter example)

Inductor and diode current waveforms

peak current:

$$i_{pk} = \frac{V_g}{L} D_1 T_s$$

average diode current:

$$\langle i_D \rangle = \frac{1}{T_s} \int_0^{T_s} i_D(t) dt$$

triangle area formula:

$$\int_0^{T_s} i_D(t) dt = \frac{1}{2} i_{pk} D_2 T_s$$

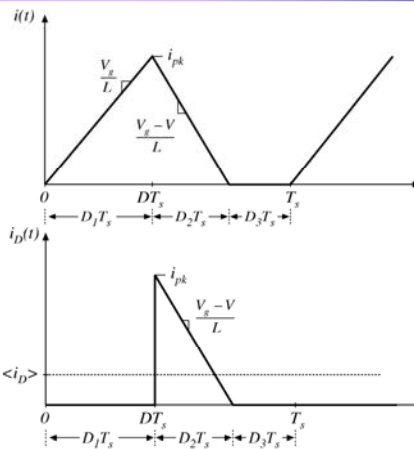

Equate diode current to load current

average diode current:

$$\langle i_D \rangle = \frac{1}{T_s} \left(\frac{1}{2} i_{pk} D_2 T_s \right) = \frac{V_g D_1 D_2 T_s}{2L}$$

equate to dc load current:

$$\frac{V_g D_1 D_2 T_s}{2L} = \frac{V}{R}$$

Solution for V

Two equations and two unknowns (V and D_2):

$$V = \frac{D_1 + D_2}{D_2} V_g \quad (\text{from inductor volt-second balance})$$

$$\frac{V_g D_1 D_2 T_s}{2L} = \frac{V}{R} \quad (\text{from capacitor charge balance})$$

Eliminate D_2 , solve for V . From volt-sec balance eqn:

$$D_2 = D_1 \frac{V_g}{V - V_g}$$

Substitute into charge balance eqn, rearrange terms:

$$V^2 - V V_g - \frac{V_g^2 D_1^2}{K} = 0$$

Solution for V

$$V^2 - VV_g - \frac{V_g^2 D_1^2}{K} = 0$$

Use quadratic formula:

$$\frac{V}{V_g} = \frac{1 \pm \sqrt{1 + 4D_1^2 / K}}{2}$$

Note that one root leads to positive V , while other leads to negative V . Select positive root:

$$\frac{V}{V_g} = M(D_1, K) = \frac{1 + \sqrt{1 + 4D_1^2 / K}}{2}$$

where $K = 2L / RT_s$
 valid for $K < K_{crit}(D)$

Transistor duty cycle $D =$ interval 1 duty cycle D_1

Boost converter characteristics

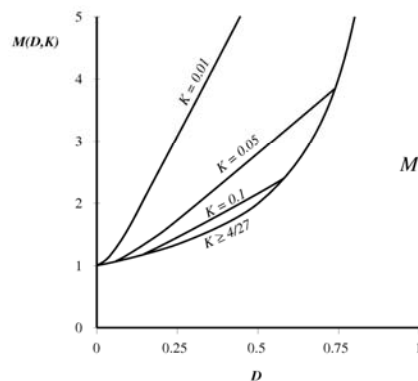

$$M = \begin{cases} \frac{1}{1-D} & \text{for } K > K_{crit} \\ \frac{1 + \sqrt{1 + 4D^2 / K}}{2} & \text{for } K < K_{crit} \end{cases}$$

Approximate M in DCM:

$$M \approx \frac{1}{2} + \frac{D}{\sqrt{K}}$$

Summary of DCM characteristics

Table 5.2. Summary of CCM-DCM characteristics for the buck, boost, and buck-boost converters

Converter	$K_{crit}(D)$	DCM $M(D,K)$	DCM $D_2(D,K)$	CCM $M(D)$
Buck	$(1 - D)$	$\frac{2}{1 + \sqrt{1 + 4K/D^2}}$	$\frac{K}{D} M(D,K)$	D
Boost	$D(1 - D)^2$	$\frac{1 + \sqrt{1 + 4D^2/K}}{2}$	$\frac{K}{D} M(D,K)$	$\frac{1}{1 - D}$
Buck-boost	$(1 - D)^2$	$-\frac{D}{\sqrt{K}}$	\sqrt{K}	$-\frac{D}{1 - D}$

with $K = 2L / RT_s$. DCM occurs for $K < K_{crit}$.

Summary of DCM characteristics

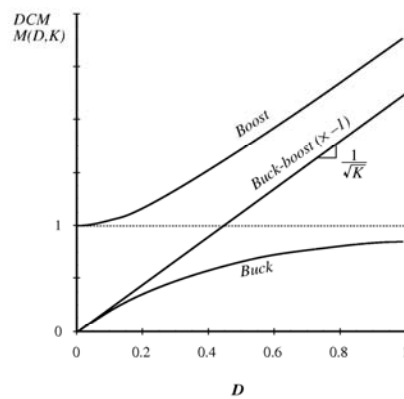

- DCM buck and boost characteristics are asymptotic to $M = 1$ and to the DCM buck-boost characteristic
- DCM buck-boost characteristic is linear
- CCM and DCM characteristics intersect at mode boundary. Actual M follows characteristic having larger magnitude
- DCM boost characteristic is nearly linear

Summary of key points

1. The discontinuous conduction mode occurs in converters containing current- or voltage-unidirectional switches, when the inductor current or capacitor voltage ripple is large enough to cause the switch current or voltage to reverse polarity.
2. Conditions for operation in the discontinuous conduction mode can be found by determining when the inductor current or capacitor voltage ripples and dc components cause the switch on-state current or off-state voltage to reverse polarity.
3. The dc conversion ratio M of converters operating in the discontinuous conduction mode can be found by application of the principles of inductor volt-second and capacitor charge balance.

Summary of key points

4. Extra care is required when applying the small-ripple approximation. Some waveforms, such as the output voltage, should have small ripple which can be neglected. Other waveforms, such as one or more inductor currents, may have large ripple that cannot be ignored.
5. The characteristics of a converter changes significantly when the converter enters DCM. The output voltage becomes load-dependent, resulting in an increase in the converter output impedance.

Part II

Converter Dynamics and Control

7. AC equivalent circuit modeling
8. Converter transfer functions
9. Controller design
10. Input filter design
11. AC and DC equivalent circuit modeling of the discontinuous conduction mode
12. Current programmed control

Chapter 7. AC Equivalent Circuit Modeling

- 7.1 Introduction
- 7.2 The basic AC modeling approach
- 7.3 State-space averaging
- 7.4 Circuit averaging and averaged switch modeling
- 7.5 The canonical circuit model
- 7.6 Modeling the pulse-width modulator
- 7.7 Summary of key points