



The Future of Analog IC Technology®

# EV6532-R-00A 5V to 60V, Three-Phase Brushless DC Motor Pre-Driver Evaluation Board

## DESCRIPTION

The EV6532-R-00A is an evaluation board for the MP6532GR, a three-phase BLDC motor pre-driver.

It operates from a supply voltage of up to 60V. It is configured to drive three half-bridges consisting of six N-channel Power MOSFETs. The rotor position information is provided by the Hall sensors assembled in the motor and the driving control signals are generated by the external controller, such as MCU, FPGA, etc.

## ELECTRICAL SPECIFICATIONS

Parameter	Symbol	Value	Units
Input Voltage	V <sub>IN</sub>	5 - 60	V
OC_REF	OC_REF	0.1 - 2	V
Hall Voltage	V <sub>H</sub>	3.3 or 5	V

## FEATURES

- Wide 5V to 60V Input Voltage Range
- Programmable OCP Threshold
- Support 100% Duty Cycle Operation
- OCP, OTP
- Fault Indication Output

## APPLICATIONS

- Three-Phase Brushless DC Motors and Permanent Magnet Synchronous Motors
- Power Drills
- Impact Drivers
- E-Bike

All MPS parts are lead-free, halogen-free, and adhere to the RoHS directive. For MPS green status, please visit the MPS website under quality assurance. "MPS" and "The Future of Analog IC Technology" are registered trademarks of Monolithic Power Systems, Inc.

## EV6532-R-00A EVALUATION BOARD

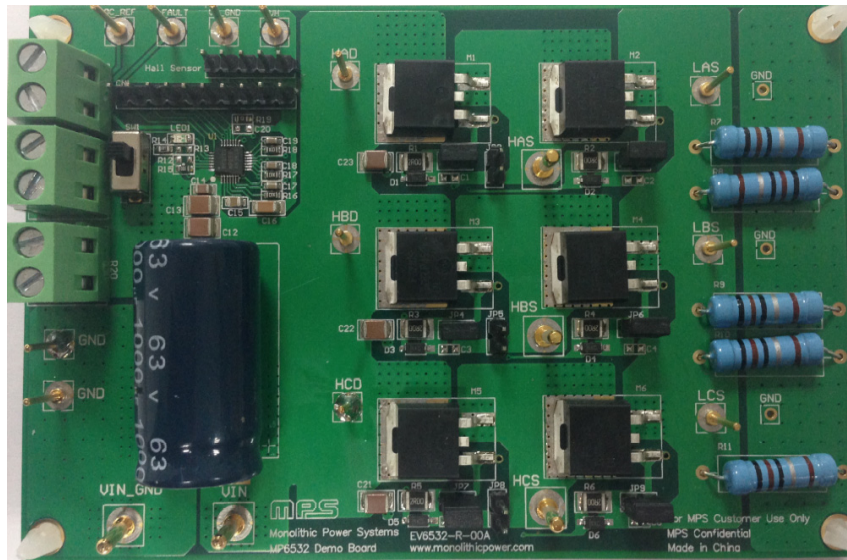

(L x W x H) 4.68" x 3.12" x 0.4"  
(11.7cm x 7.8cm x 1cm)

Board Number	MPS IC Number
EV6532-R-00A	MP6532GR

# EVALUATION BOARD SCHEMATIC

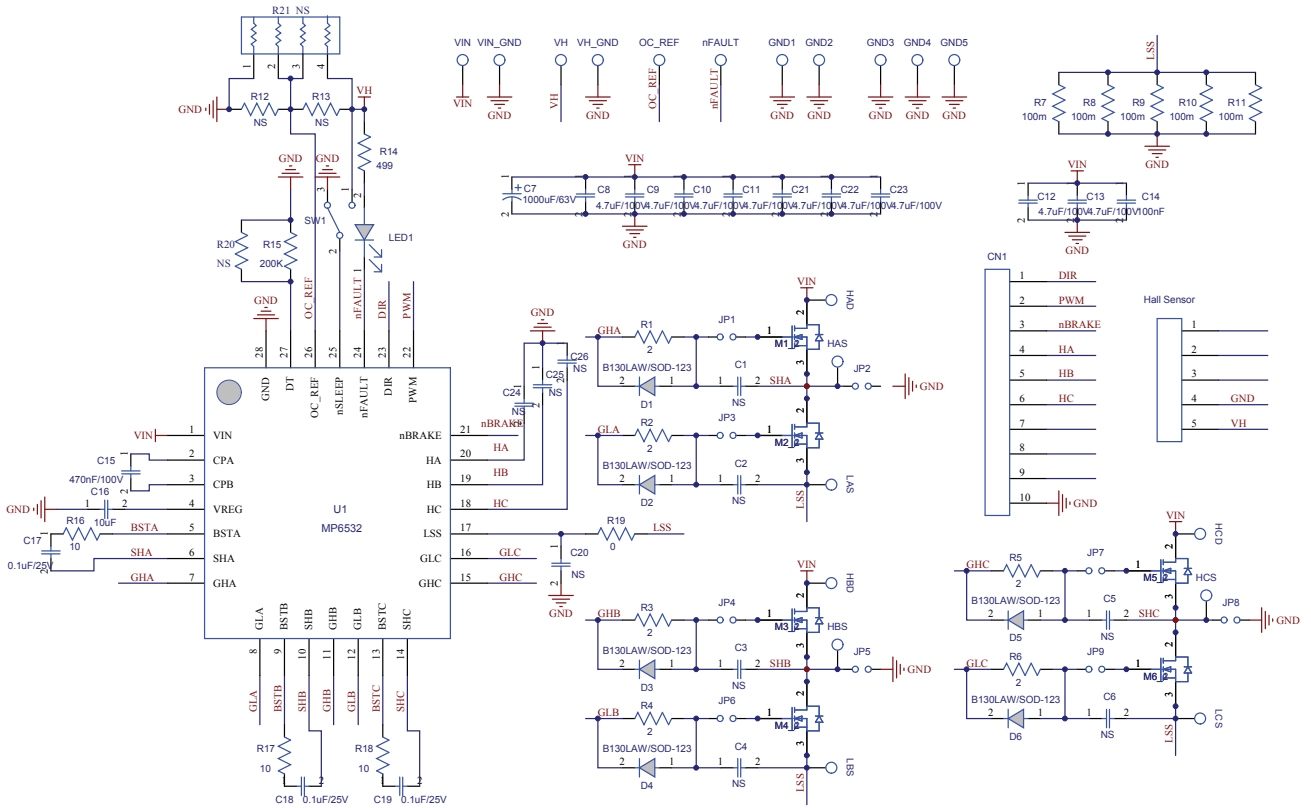

**EV6532-R-00A BILL OF MATERIALS**

Qty	RefDes	Value	Description	Package	Manufacturer	Manufacturer P/N
14	C1,C2,C3,C4,C5, C6,C20,C24,C25, C26,R12,R13, R20,R21	NS				
1	C7	1000µF	Electrolytic Cap. 63V	DIP	Jianghai	CD263-63V1000
9	C8,C9,C10,C11, C12,C13,C21, C22,C23	4.7µF	Ceramic Cap. 100V, X7S	1210	TDK	C3225X7S2A475K
1	C14	100nF	Ceramic Cap. 100V, X7R	0805	TDK	CGA4J2X7R2A104K
1	C15	470nF	Ceramic Cap. 100V, X7R	0805	Murata	GRM21BR72A474KA73L
1	C16	10µF	Ceramic Cap. 25V, X5R	1206	Murata	GRM31CR61E106KA12L
3	C17,C18,C19	0.1µF	Ceramic Cap. 25V, X7R	0603	Murata	GRM188R71E104KA01D
6	R1,R2,R3,R4, R5,R6	20Ohm	Film Resistor. 1%	1210	Yageo	RC1210FR-072RL
5	R7,R8,R9,R10, R11	100mOhm	Resistor. 2W	DIP	闽达	
1	R14	499Ohm	Film Resistor. 1%	0603	Yageo	RC0603FR-07499RL
1	R15	200k	Film Resistor ,1%	0603	Yageo	RC0603FR-07200KL
3	R16,R17,R18,	10Ohm	Film Resistor ,1%	0603	Yageo	RC0603FR-0710RL
1	R19	0Ohm	Film Resistor ,1%	0603	Yageo	RC0603FR-070RL
6	D1,D2,D3,D4,D5, D6		Schottky Diode. 30V, 1A	SOD-123	Diodes	B130LAW-7-F
6	M1,M2,M3,M4, M5,M6		N-channel MOSFET, 100V,57A, Qg=130nC, 23mOhm@Vgs=10V, Id=28A	TO-263	IR	IRF3710STRLPBF
1	LED1		LED. 红光	0805	Bright LED	BL-HUF35A-TRB
1	SW1		Button			SS-12D01EG4
9	JP1,JP2,JP3,JP4, JP5,JP6,JP7, JP8,JP9		2PIN. 2.54MM			61304011121
6	JP1,JP3,JP4,JP6, JP7,JP9		2.54MM Short Jumper			60900213421
1	CN1		10PIN. 2.54MM			61304011121
1	Hall Sensor		5PIN. 2.54MM			61304011121
5	VIN, VIN_GND, HAS, HBS, HCS		2.0 公针			
12	OC_REF, nFAULT,VH_GND ,VH,GND,GND, HAD,HBD,HCD, LAS,LBS,LCS		1.0 公针			
1	U1		Three-Phase BLDC Motor Pre-Driver	QFN28 (4x4mm)	MPS	MP6532GR

PRINTED CIRCUIT BOARD LAYOUT

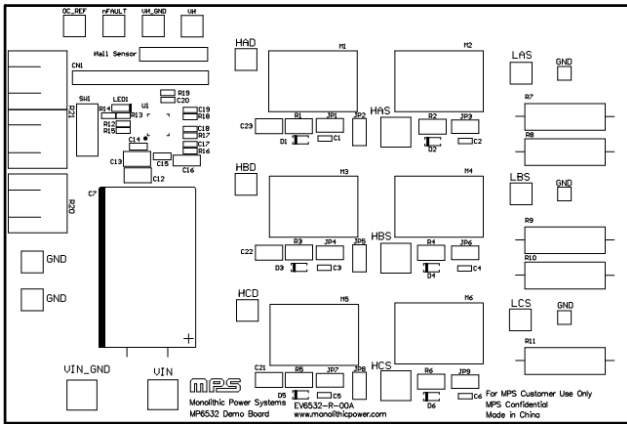

Figure 1: Top Silk Layer

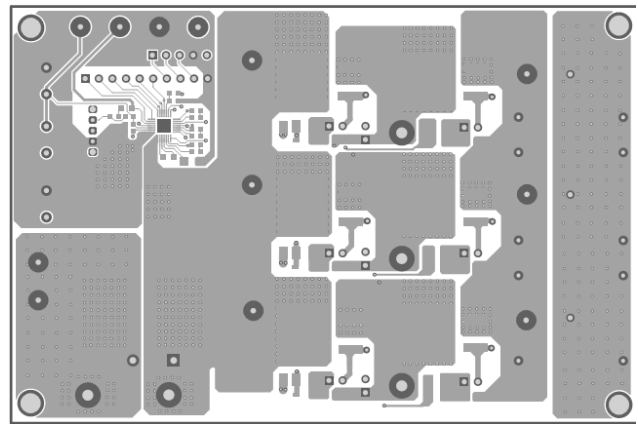

Figure 2: Top Layer

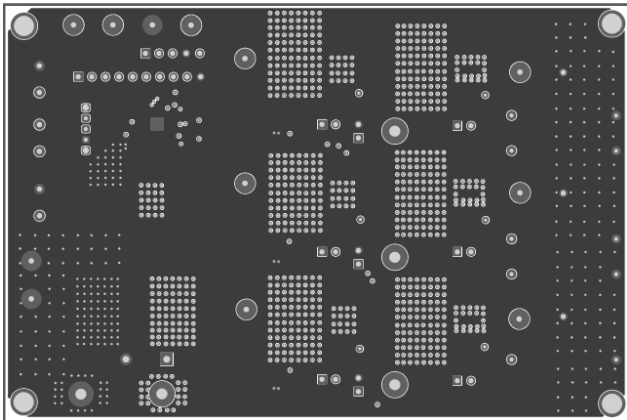

Figure 3: Inner 1 Layer

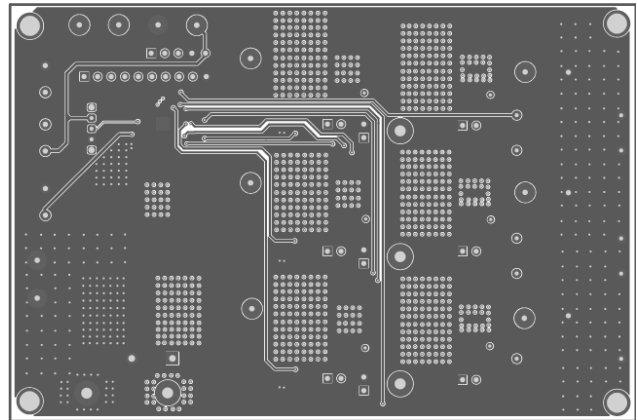

Figure 4: Inner 2 Layer

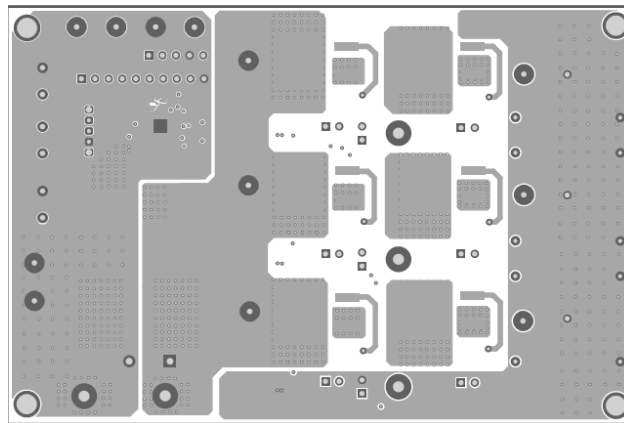

Figure 5: Bottom Layer

## QUICK START GUIDE

1. Attach the input voltage ( $5V \leq V_{IN} \leq 60V$ ) and input ground to the VIN and GND connectors respectively.
2. Attach a 3.3V or 5V constant voltage to the VH connector and switch the SW1 to the position 1(Top side) to enable the chip.
3. Attach the OCP reference voltage ( $0.1V \leq V_{REF} \leq 2V$ ) to the OC\_REF connector to set OCP threshold.
4. Attach the hall signals coming from the motor to the CN1 connector. Attach the hall sensor power supply to the Hall Sensor connector.
5. Attach the driving control signals generated by the external controller to the CN1 connector.